

LISTINO PREZZI  
*PRICE LIST*



IVA ESCLUSA  
*TAX NOT INCLUDED*



2017

# Condizioni generali di vendita ITALIA

**IL PRESENTE LISTINO PREZZI ANNULLA E SOSTITUISCE I PRECEDENTI.**

**I PREZZI SI INTENDONO IVA ESCLUSA**

## **TRASPORTO**

Porto franco per importi superiori a **€ 600,00** al netto dello sconto, IVA esclusa. Per spedizioni di ordini con importi inferiori a € 600,00 netto saranno addebitate in fattura spese di trasporto secondo le seguenti tariffe:

### **NORD**

Piemonte/ Valle d'Aosta/ Liguria/  
Lombardia/ Triveneto/ Emilia Romagna **€ 30.00**

### **CENTRO**

Toscana/ Marche/ Umbria/  
Lazio/ Abruzzo/ Molise **€ 34.00**

### **SUD**

Campania/ Puglia/ Basilicata **€ 36.00**

### **SUD e ISOLE**

Calabria/ Sicilia/ Sardegna **€ 40.00**

## **RECLAMI e RESI**

La merce viaggia con spedizione assicurata, pertanto i colli devono essere controllati al momento dello scarico. Qualsiasi anomalia deve essere segnalata immediatamente sul palmare del corriere (es. colli danneggiati, rumore di cocci, ecc.). In assenza di tale immediata segnalazione Penta S.r.l. declina ogni responsabilità per danni causati dal trasporto.

Ogni reso di merce deve essere autorizzato da Penta S.r.l. ed effettuato in porto franco presso la sede aziendale.

La merce resa deve viaggiare adeguatamente protetta nell'imballo originale.

L'eventuale accredito su merci rese in perfetto stato, inusate e nell'imballo originale, sarà concordato con Penta S.r.l.

## **RICAMBI E COMPONENTI**

Per l'invio di pezzi di ricambio e/o componenti, se non aggiunti ad ordini in spedizione, sarà addebitato il costo del trasporto, comprensivo di IVA, e il pagamento, per importi inferiori a € 150,00 netto, dovrà essere effettuato in contrassegno.

# Index

## **COLLEZIONI/COLLECTION**

Aba Hi-tech	pag. 5
Aba Vip	pag. 6
Acorn	pag. 7
Bag	pag. 8
Bag outdoor	pag. 9
Baloon	pag. 10
Bodona	pag. 11
Bridget	pag. 12
Cenere	pag. 14
C'hi	pag. 15
China	pag. 17
Ciak	pag. 18
Cryon	pag. 19
Glo	pag. 20
Jeï Jeï	pag. 22
Je Suis	pag. 24
Juliette	pag. 25
Kaskade	pag. 26
Kelly	pag. 27
Kimilla	pag. 28
Klint	pag. 29
Kori	pag. 30
Labo	pag. 31
Loop	pag. 34
Lula	pag. 32
Luume	pag. 33
Magoo	pag. 34
Mamì	pag. 35
MoM Family	pag. 39

New Classic	pag. 41
New Classic terra	pag. 42
Panona	pag. 43
Planet	pag. 44
Polar	pag. 45
Stilo	pag. 46
Taaac	pag. 46
Tic&Toc	pag. 47
Tocco	pag. 48
Tosca	pag. 49
Vertigo	pag. 50
Wonder	pag. 51
Wood	pag. 52
Woody	pag. 53
4000	pag. 53

## **SOSPENSIONI TESSUTO/FABRIC PENDANTS**

Sospensioni tessuto	pag. 55
Extra Large	pag. 62
Sospensioni PVC specchiato	pag. 64
Club House	pag. 66
Luxury	pag. 69
Slide	pag. 71
Up-down	pag. 72
Vanity	pag. 73

## **PIASTRE E ROSONI/PLATES AND CANOPIES**

Piastre e Rosoni/ <i>Plates&amp;Canopies</i>	pag. 75
Piastre art. Wonder/ <i>Plates art. Wonder</i>	pag. 78

# Condizioni generali di vendita

Il presente listino sostituisce ed annulla qualsiasi precedente.

I prezzi si intendono al pubblico, IVA esclusa.

I prezzi sono espressi in Euro.

## TRASPORTO

Resa Franco Fabbrica: la merce viaggia a rischio e pericolo del committente.

Resa Franco Destino: la merce viaggia con spedizione assicurata, pertanto i colli devono essere controllati al momento dello scarico. Qualsiasi anomalia deve essere segnalata immediatamente sul palmare del corriere (es. colli danneggiati, rumore di cocci, ecc.). In assenza di tale immediata segnalazione Penta S.r.l. declina ogni responsabilità per danni causati dal trasporto.

La merce è attentamente controllata e accuratamente imballata prima della spedizione, di conseguenza Penta S.r.l. declina ogni responsabilità per danni causati dal trasporto.

## IMBALLO

Il costo dell'imballo, ove diversamente indicato, è incluso nel prezzo dell'articolo.

L'imballo è composto da scatole in cartone vulcanizzato, schiumato a caldo e protezioni Air Plus.

## RECLAMI E RESI

Reclami per difetti apparenti e occulti o articoli non conformi all'ordine, devono essere comunicati a Penta S.r.l. a mezzo e-mail o fax entro tre giorni dal ricevimento della merce.

Ogni reso di merce deve essere autorizzato da Penta S.r.l. ed effettuato in porto franco presso la sede aziendale.

Non sia accettano reclami per uso improprio dell'articolo o dovuti al mancato rispetto delle norme di sicurezza riportate sulle istruzioni di montaggio di cui sono dotati tutti i prodotti.

## TOLLERANZE

Le dimensioni ed i colori indicati nei dati tecnici hanno una tolleranza dovuta alla lavorazione caratteristica dei vetri soffiati.

Ogni articolo è sottoposto a meticolosi controlli di qualità, pertanto apparenti difetti, come bolle o variazioni dei toni di colore dei vetri, sono riconosciuti come pregi a conferma della lavorazione artigianale.

## PROPRIETA' DELLA MERCE

Penta S.r.l. si riserva la proprietà della merce fino al completo, avvenuto, irrevocabile, pagamento della stessa.

## VARIE

Immagini e rappresentazioni dei prodotti in listino, catalogo e sito possono differire dall'aspetto reale della merce.

Penta S.r.l. si riserva il diritto in qualsiasi momento e senza preavviso di eliminare prodotti dalla collezione e di apportare agli stessi variazioni di prezzo o modifiche derivanti da esigenze di carattere tecnico e/o commerciale.

I prezzi esposti nel presente listino sono da intendersi esclusivamente per materiale conforme agli standard tecnici indicati nel listino stesso. Ogni eventuale richiesta di materiale conforme a standard diversi dovrà essere oggetto di quotazione specifica.

La rappresentazione estetica dei cavi è indicativa della versione Europa.

La versione UL di alcune lampade potrebbe subire variazioni di colore, materiale ed elettrificazione.

Per ogni controversia, l'unico e insindacabile Foro competente è quello di Monza (MB) - Italia.

# General sale conditions

This price – list cancels and replaces the previous ones.

The stated prices are public, taxes not included.

The prices are in Euro.

## **TRANSPORT**

Ex – Factory: goods travel at complete risk of the buyer.

Delivery duty paid or unpaid: before accepting the goods from the forwarder in charge for the dispatch, the buyer must check all details of the shipments, the quantity of the boxes and the conditions of the packaging. He must also immediately inform the forwarder of any noticed irregularity or breakage. If it will not be possible to check the goods during the delivery, the buyer has to accept the goods “with reserve” and inform Penta S.r.l. and the forwarder of possible irregularities or breakages within 3 days from the delivery date. The forwarder is responsible for the shortages and damages, which can not be charged to the supplier for any reason.

## **PACKAGING**

The cost of the packaging, except from where otherwise indicated, is included in the price of each item.

The packaging consists on cartoon boxes, polyurethane foam and air plus protection.

## **CLAIMS AND RETURNED GOODS**

We will only accept claims for damaged goods or for items other than those ordered within 3 days from receipt of the goods, made in written.

Any returned item must be previously authorized by Penta S.r.l. in writing and the delivery must be free to our warehouse in Cabiato. We do not accept any claim for improper use of the item or for not sticking to the safety rules indicated on the assembly instructions that will be found together with all items.

## **ALLOWANCE**

Dimensions and colours listed in the technical details allows small differences due to blown glasses hand-made productions. Each item is carefully checked, therefore apparent imperfections, such as bubbles or nuances in the glass colour, have to be recognized as qualities and signs of the artisan's craftsmanship.

## **GOODS' OWNERSHIP**

Penta S.r.l. will be the sole owner of the goods until the complete, executed and irrevocable payment of our invoice.

## **OTHERS**

Images and representations of the products in our price – list, catalogue and web site, could be different from the real aspect of the item.

Due to technical and commercial requirements, both characteristics and models could be charged without any previous notice.

The prices mentioned in this price – list should be referred to only for items that respect all technical standards details indicated in the price itself. Any request for custom made material will be quoted specifically.

Characteristics of the cables indicated in the price-list are related to the EU standards only.

For UL, cables can differ in terms of colours, material and electrification.

Any dispute will be judged by the court of Monza (MB).



# Aba Hi-tech

Massimo Belloni 1995

Lampade con struttura in metallo nichel satinato. Paralume nei tessuti della collezione, **escluso PVC specchiato e plissé seta a mano.**

Lamps with structure in nickel satin metal. Shade in the fabrics of the collection, **mirroring PVC and hand made silk plissé excluded.**

Lampen mit Struktur aus Metall Nickel satiniert. Schirm in den verschiedenen Materialien der Kollektion, **Spiegel-PVC und Handgefertigte Seide Plissé nicht einschliesslich.**







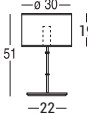

Lampes avec structure en métal nickel satiné. Abat-jour dans les tissus de la collection, **PVC réfléchissant et plissé de soie à main pas inclus.**

Lámparas con estructura en níquel satinado. Pantalla en los tejidos de la colección, **excepto PVC espejado y plissé de seda hecho a mano.**

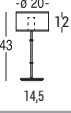

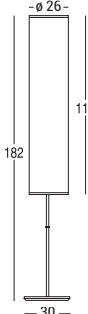
9402

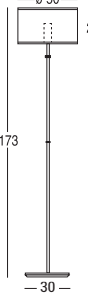
Tavolo Table

Terra Floor

codice code	cavo elettrico cm electric cable cm	IMBALLO CM/PACKAGING CM SH = Shade ST = Structure	peso netto kg. net weight kg.	peso lordo kg. gross weight kg.	lampadina bulb	€ iva esclusa € tax not included
<b>9402-03</b> LARGE 	160	SH 45 x 45 x 28 h.	0,5	1,3	 1 x 10W LED - E27 oppure/or  1 x max 100W - E27 Halo/Fluo	cat. A/B <b>365,00</b>
		ST 31 x 31 x 62 h.	3,4	4,2	cat. Extra <b>385,00</b>	
<b>9402-01</b> SMALL 	160	SH 31 x 31 x 32 h.	0,3	0,7	 1 x 5W LED - E14 oppure/or  1 x max 60W - E14 Halo/Fluo	cat. A/B <b>255,00</b>
		ST 28 x 28 x 49 h.	1,7	2,2	cat. Extra <b>265,00</b>	
<b>9402-12</b> LARGE 	200	SH 33 x 33 x 124 h.	0,8	2,8	 6 x max 60W E14 oliva Halo  Dimmer	cat. A/B <b>690,00</b>
		ST 36 x 36 x 184 h.	7,5	10,2	cat. Extra <b>735,00</b>	
<b>9402-11</b> SMALL 	200	SH 55 x 55 x 35 h.	0,5	2,5	 1 x max 100W E27 Halo  Dimmer	cat. A/B <b>630,00</b>
		ST 36 x 36 x 184 h.	7,5	9,5	cat. Extra <b>650,00</b>	

Lampadina esclusa / Bulb not included

codice code	cavo elettrico cm electric cable cm	IMBALLO CM/PACKAGING CM SH = Shade ST = Structure	peso netto kg. net weight kg.	peso lordo kg. gross weight kg.	lampadina bulb	€ iva esclusa € tax not included
9402-30		SH 31 x 31 x 32 h.	0,2	0,8	 1 x 5W LED - E14 oppure/or	cat. A/B <b>245,00</b>
		ST 31 x 31 x 32 h.	0,4	0,6	 1 x max 60W - E14 Halo/Fluo	cat. Extra <b>255,00</b>

Lampadina esclusa / Bulb not included

# Aba Vip

Massimo Belloni 1995/2008





Lampade con struttura in metallo nichel satinato. Paralume nei tessuti della collezione, **escluso PVC specchiato e plissé seta a mano**. Chiusura inferiore e superiore totale in plexiglas.

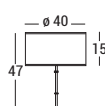

Lamps with structure in nickel satin metal. Shade in the fabrics of the collection, **mirroring PVC and hand made silk plissé excluded**. Complete bottom and top closure in plexiglas.

Lampen mit Struktur aus Metall Nickel satiniert. Schirm in den verschiedenen Materialien der Kollektion, **Spiegel-PVC und Handgefertigte Seide Plissé nicht einschliesslich**. Ganze Ober- und Unterabdeckung aus Plexiglas.

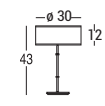
Lampes avec structure en métal nickel satiné. Abat-jour dans les tissus de la collection, **PVC réfléchissant et plissé de soie à man pas inclus**. Fermeture inférieure et supérieure complète en plexiglas.

Lámparas con estructura en níquel satinado. Pantalla en los tejidos de la colección, **excepto PVC espejado y plissé de seda hecho a mano**. Cierre inferior y superior total en plexiglas.

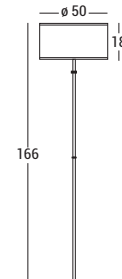
codice code	cavo elettrico cm electric cable cm	IMBALLO CM/PACKAGING CM SH = Shade ST = Structure	peso netto kg. net weight kg.	peso lordo kg. gross weight kg.	lampadina bulb	€ iva esclusa € tax not included
9403-03 LARGE		SH 45 x 45 x 28 h.	3,4	4,2	 1 x 8W LED-E27 oppure/or	cat. A/B <b>385,00</b>
		ST 31 x 31 x 62 h.	4,5	5,3	 1 x max 60W - E27 Halo/Fluo	cat. Extra <b>395,00</b>
9403-01 SMALL		SH 31 x 31 x 32 h.	1,7	2,2	 1 x 5W LED - E14 oppure/or	cat. A/B <b>295,00</b>
		ST 28 x 28 x 49 h.	2,5	3,3	 1 x max 40W - E14 Halo/Fluo	cat. Extra <b>305,00</b>

9403-11		SH 55 x 55 x 35 h.	4,5	6	 1 x max 100W E27 Halo	cat. A/B <b>680,00</b>
		ST 36 x 36 x 184 h.	8,5	12,5	 Dimmer	cat. Extra <b>710,00</b>

Lampadina esclusa / Bulb not included



# Acorn

Matteo Bianchi 2015

Lampada sospensione in cemento con diffusore in vetro satinato o trasparente. **Protezione IP65** contro gli spruzzi d'acqua da ogni direzione.

Pendant lamp with structure in cement with shade in frosted or transparent glass. **Protection IP65** against water from any direction.

Hängeleuchte mit Struktur aus Zement mit Schirm aus matt oder transparent Glas. **Schutz IP65** vor Wasser aus alle Direktionen.

Suspension avec structure en béton avec abat-jour en verre mat ou transparent. **Protection IP65** contre l'eau de tous les directions.

Lámpara de suspensión con estructura de cemento con difusor en cristal satinado o transparente. **Protección IP65** contra salpicaduras de agua desde cualquier dirección.

1501

Sospensioni Pendant

codice code	cavo elettrico cm electric cable cm	IMBALLO CM/PACKAGING CM SH = Shade ST = Structure	peso netto kg. net weight kg.	peso lordo kg. gross weight kg.	lampadina bulb	€ iva esclusa € tax not included
1501-20	200	27 x 27 x 37 h.	2	3	Led integrato non sostituibile/ Led included not replaceable  LED 7W-3000K	495,00

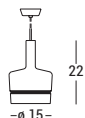

## Esempi di installazione/Installation examples



Singola  
Single

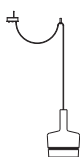

Singola con decentramento  
Single decentralized

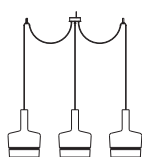

Multiple con decentramento  
Multiple decentralized

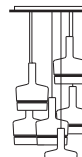

Composizione con piastra  
Cluster with plate

Piastre e rosoni pag. 75  
Plates and canopies pag. 75

# Bag

Carlo Colombo 2007

Lampade in espanso termoplastico nei colori lucidi: bianco, nero.

Lamps in thermoplastic expansion in the glossy colours: white, black.

Lampen aus Thermoplastische Expansion in den glänzenden Farben: Weiß, Schwarz.







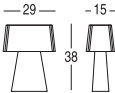

Lampes en expansion thermoplastique dans les couleurs poli: blanc, noir.

Lámparas en expansión termoplástica en los colores brillantes: blanco, negro.

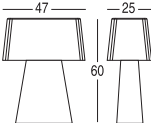
0706

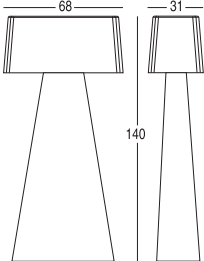
Tavolo Table

Terra Floor

codice code		cavo elettrico cm electric cable cm	IMBALLO CM/PACKAGING CM SH = Shade ST = Structure	peso netto kg. net weight kg.	peso lordo kg. gross weight kg.	lampadina bulb	€ iva esclusa € tax not included
<b>0706-01</b> SMALL		180	40 x 26 x 50 h.	2,1	3,5	 2x5W LED - E14 oppure/or  2xmax 40W - E14 Halo	<b>395,00</b>
<b>0706-03</b> LARGE		180	42 x 62 x 81 h.	5,3	8,5	 3x5W LED - E14 oppure/or  3xmax 40W - E14 Halo/Fluo	<b>765,00</b>
<b>0706-10</b>		200	48 x 82 x 160 h.	13,2	22,5	SUP.  1x5W LED - E14 oppure/or  1xmax 60W - E14 Halo/Fluo  INF.  2 x max 100W - E27 Halo  Dimmer	<b>1.150,00</b>

Lampadina esclusa / Bulb not included

# Bag outdoor

Carlo Colombo 2008

Lampade da esterno in espanso termoplastico nei colori lucidi: bianco, nero.

**Grado di protezione IP44:**

- Apparecchio a prova di penetrazione di oggetti solidi con  $\varnothing$  superiore a 1 mm  
- Apparecchio protetto contro gli spruzzi d'acqua da ogni direzione.

"Outdoor" lamps in thermoplastic expansion in the glossy colours: white, black.

**Protection Class IP44:**

- Protected against penetration of solid objects larger than 1 mm.  
- Protected against splashing water from any direction.

Lampen "outdoor" aus Thermoplastischer Expansion in den glänzenden Farben: Weiß, Schwarz.

**Schutzklass IP44:**

- Geschützt gegen Eindringung von soliden Körpern, die größer als 1 mm sind.  
- Geschützt gegen Wässerspritzer von irgendeiner Richtung.

Lampes "outdoor" en espansión termoplastique dans les couleurs: blanc, noir.

**Classe de protection IP44:**

- Protégé contre pénétration d'objets solides plus grands que 1 mm.  
- Protégé contre les projections d'eau provenant de toute direction.

Lámparas "outdoor" en expansión termoplástica en los colores brillantes: blanco, negro.

**Clase de protección IP44:**

- Protegido contra cuerpos sólidos mayores de 1 mm.  
- Protegido contra salpicaduras de agua de cualquier dirección.

0802

Tavolo Table

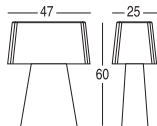
codice code	cavo elettrico cm electric cable cm	IMBALLO CM/PACKAGING CM SH = Shade ST = Structure	peso netto kg. net weight kg.	peso lordo kg. gross weight kg.	lampadina bulb	€ iva esclusa € tax not included
<b>0802-03</b> LARGE						
						
		100 (senza spina) (without plug)	42 x 62 x 81 h.	7	10,5	
					3x5W LED - E14 oppure/or 3xmax 40W - E14 Halo/Fluo	895,00

Terra Floor

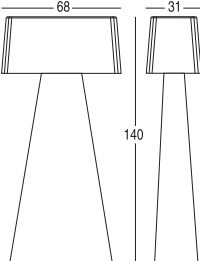
<b>0802-10</b>						
						
		100 (senza spina) (without plug)	48 x 82 x 160 h.	15	24,3	
					SUP. 1x5W LED - E14 oppure/or 1xmax 60W - E14 Halo/Fluo  INF. 2 x max 60W E14 Halo	1.255,00

Lampadina esclusa / Bulb not included

# Baloon

Sospensione con struttura metallica, rivestimento sfoderabile e lavabile in tessuto elasticizzato bianco.

Cablaggio elettrico con rosone nichel satinato e cavo in cotone rosso.

**A RICHIESTA:**

- estensione cablaggio elettrico

€ 9,00/mt + IVA

Pendant with metallic structure, removable and washable cover in elasticised white fabric.

Electrical wiring with nickel satin canopy and red cotton electrical cable.

**ON DEMAND:**

- longer electrical cable

€ 9,00/mt

Hängeleuchte mit Struktur aus Metal, beseitigbarem und waschbarem Bezug aus Weiß- barstoffe.

Deckbefestigung Nickel satiniert und rote Baumwolle Kabel.

**AUF VERLANGEN:**

- längere elektrische Kabel

€ 9,00/mt

Suspension avec structure métallique, revêtement en tissu élastique blanc qu'on peut enlever et laver.

Câblage avec calotte en nickel satiné et câble électrique en coton rouge.

**SUR DEMANDE:**

- câble électrique plus long

€ 9,00/mt

Lámpara de techo con estructura metálica, recubrimiento en tejido elástico blanco que se puede retirar y lavar. Cableado con roseton níquel satinado y cable eléctrico en algodón rojo.



**A PEDIDO:**

- cable eléctrico más largo

€ 9,00/mt

0606

Sospensioni | Pendant

codice code	cavo elettrico cm electric cable cm	IMBALLO CM/PACKAGING CM SH = Shade ST = Structure	peso netto kg. net weight kg.	peso lordo kg. gross weight kg.	lampadina bulb	€ iva esclusa € tax not included
0606-20-09	200	75 x 75 x 77 h.	2,7	8	 1 x 16W LED - E27 oppure/or  1 x max 100W - E27 Halo/Fluo	470,00

Lampadina esclusa / Bulb not included

# Bodona Umberto Asnago 1998

Lampade da tavolo e sospensioni con struttura in metallo verniciato argento. Diffusore in vetro soffiato opalino bianco o trasparente.

Table lamps and pendants with structure in silver varnished metal. Shade in blown glass: opal white or transparent.













Tisch- und Hängeleuchten mit Struktur aus silber lackiertem Metal. Schirm aus geblasenem Glas: Opalweiß oder Transparent.

Lampes à poser et suspensions avec structure en métal verni argent. Abat-jour en verre soufflé opalin blanc ou transparent.

Lámparas de mesa y de techo con estructura en metal barnizado plata. Pantalla en vidrio soplado: opal blanco o transparente.

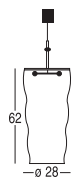
9803

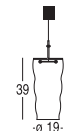
Tavolo Table

codice code		cavo elettrico cm electric cable cm	IMBALLO CM/PACKAGING CM SH = Shade ST = Structure	peso netto kg. net weight kg.	peso lordo kg. gross weight kg.	lampadina bulb	€ iva esclusa € tax not included
<b>9803-04</b> MAXI		160	SH 41 x 41 x 77 h.	3,8	5	 1 x max 250W E27 Halo	vetro opalino bianco white opal blown glass <b>670,00</b>
			ST 37 x 37 x 48 h.	6	6,8		vetro trasparente transparent glass <b>720,00</b>
<b>9803-03</b> LARGE		160	SH 31 x 31 x 62 h.	3,4	4,2	 1 x max 150W E27 Halo	vetro opalino bianco white opal blown glass <b>370,00</b>
							vetro trasparente transparent glass <b>395,00</b>
<b>9803-02</b> MEDIUM		160	SH 28 x 28 x 49 h.	1,7	2,2	 1 x max 100W E27 Halo	vetro opalino bianco white opal blown glass <b>270,00</b>
							vetro trasparente transparent glass <b>295,00</b>
<b>9803-24</b> MAXI		110	SH 41 x 41 x 77 h.	3,8	5	 1 x max 250W E27 Halo	vetro opalino bianco white opal blown glass <b>535,00</b>
			ST 45 x 45 x 28 h.	0,6	2		vetro trasparente transparent glass <b>695,00</b>
<b>9803-23</b> LARGE		110	SH 55 x 55 x 35 h.	1,6	2,6	 1 x max 150W E27 Halo	vetro opalino bianco white opal blown glass <b>395,00</b>
							vetro trasparente transparent glass <b>460,00</b>

Lampadina esclusa / Bulb not included

# Bridget

Lampade con struttura in metallo nichel satinato. Paralume semicono nei tessuti della collezione. (Escluso plissé seta a mano e PVC specchiato).

A richiesta per quantitativi:  
- ulteriori finiture metalliche  
- plissé seta a mano

Lamps with structure in nickel satin metal. Semicone shade in the fabrics of the collection. (Hand-made silk plissé and mirror ring PVC excluded).

On demand for quantity:  
- Further metal finishes  
- Hand-made silk plissé.

Leuchten mit Struktur aus Nickel satiniert Metall. Halbkegel Schirm aus den Stoff- und Farben von unsere Kollektion. (Handgefertigte Seide Plissé und Spiegel-PVC nicht einschliesslich).

Auf Anfrage für Mengen:  
- Weitere Metall Ausföhrunge  
- Handgefertigte Seide Plissé

Lampes avec structure en metal nickel satiné. Abat-jours semicone dans les tissus de la collection. (Plissé soie à main et PVC réfléchissant pas inclus).



Sur demand pour quantité:  
- Finition supplémentaire du metal  
- Plissé soie à man

Lámparas con estructura en metal níquel satinado. Pantallas semi-cono en los tejidos de la colección. (Excepto plissé de seda hecho a mano y PVC espejado).

Bajo pedido para cantidades:  
- Extra acabado en metal  
- Plissé de seda hecho a mano

1003

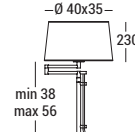
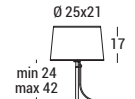
Tavolo Table

codice code	cavo elettrico cm electric cable cm	IMBALLO CM/PACKAGING CM SH = Shade ST = Structure	peso netto kg. net weight kg.	peso lordo kg. gross weight kg.	lampadina bulb	€ iva esclusa € tax not included
<b>1003-03</b> LARGE EXTENSIBLE		SH 45 x 45 x 28 h. ST 31 x 31 x 62 h.	0,5 2,5	1,3 3,8	1 x 8W LED - E27 oppure/or 1 x max 60W - E27 Halo/Fluo	cat. A/B <b>325,00</b> cat. Extra <b>345,00</b>
<b>1003-04</b> LARGE EXTENSIBLE ADJUSTABLE		SH 45 x 45 x 28 h. ST 31 x 31 x 62 h.	0,5 2,6	1,3 3,9	1 x 8W LED - E27 oppure/or 1 x max 60W - E27 Halo/Fluo	cat. A/B <b>415,00</b> cat. Extra <b>440,00</b>
<b>1003-01</b> SMALL EXTENSIBLE		SH 31 x 31 x 32 h. ST 28 x 28 x 49 h.	0,3 1,6	0,7 2,8	1 x 5W LED - E14 oppure/or 1 x max 60W - E14 Halo/Fluo	cat. A/B <b>270,00</b> cat. Extra <b>285,00</b>
<b>1003-02</b> SMALL EXTENSIBLE ADJUSTABLE		SH 31 x 31 x 32 h. ST 28 x 28 x 49 h.	0,3 1,7	0,5 2,9	1 x 5W LED - E14 oppure/or 1 x max 60W - E14 Halo/Fluo	cat. A/B <b>355,00</b> cat. Extra <b>370,00</b>

Lampadina esclusa / Bulb not included

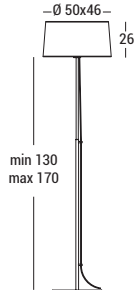
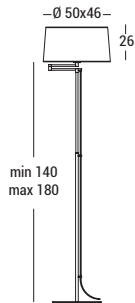
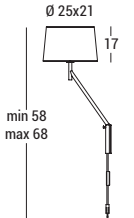
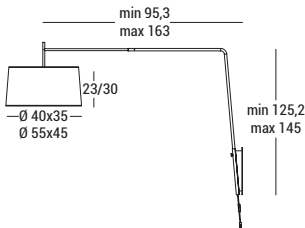
codice code	cavo elettrico cm electric cable cm	IMBALLO CM/PACKAGING CM SH = Shade ST = Structure	peso netto kg. net weight kg.	peso lordo kg. gross weight kg.	lampadina bulb	€ iva esclusa € tax not included	
<b>1003-10</b> FLOOR EXTENSIBLE		200	SH 55 x 55 x 35 h. ST 40 x 40 x 148 h.	0,5 6	2,5 12,5	1 x 10W LED - E27 oppure/or 1 x max 100W - E27 Halo/Fluo	cat. A/B <b>595,00</b> cat. Extra <b>625,00</b>
<b>1003-16</b> FLOOR EXTENSIBLE ADJUSTABLE		200	SH 55 x 55 x 35 h. ST 40 x 40 x 148 h.	0,5 6,5	2,5 13,0	1 x 10W LED - E27 oppure/or 1 x max 100W - E27 Halo/Fluo	cat. A/B <b>725,00</b> cat. Extra <b>750,00</b>
<b>1003-31</b> SMALL	 Regolabile in altezza e orientabile <i>Extensible ad adjustable</i>	200	SH 31 x 31 x 32 h. ST 31 x 31 x 62 h.	0,3 0,7	0,7 3,2	1 x 5W LED - E14 oppure/or 1 x max 60W - E14 Halo/Fluo	cat. A/B <b>295,00</b> cat. Extra <b>315,00</b>
<b>1003-34</b> LARGE	 Braccio estensibile, orientabile e regolabile in altezza <i>Extensible and adjustable arm</i>	200	SH 66 x 66 x 48 h. ST 68 x 68 x 35 h.	0,5 2	1,3 7	1 x 10W LED - E27 oppure/or 1 x max 100W - E27 Halo/Fluo	cat. A/B <b>865,00</b> cat. Extra <b>895,00</b>

Lampadina esclusa / Bulb not included

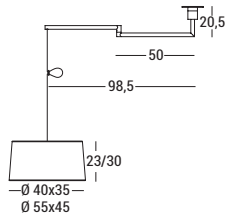
codice code	cavo elettrico cm electric cable cm	IMBALLO CM/PACKAGING CM SH = Shade ST = Structure	peso netto kg. net weight kg.	peso lordo kg. gross weight kg.	lampadina bulb	€ iva esclusa € tax not included
<b>1003-20</b> ADJUSTABLE	 <p>Braccio orientabile e paralume regolabile in altezza adjustable arm and shade</p>	150	SH 66 x 66 x 48 h.	0,5	1,3	cat. A/B <b>695,00</b>

Lampadina esclusa / Bulb not included

## Cenere 1995



Plafoniera e applique con struttura in metallo nichel satinato.  
Diffusore in vetro sabbato.

Ceiling and wall lamp with structure in nickel satin metal.  
Shade in mat glass.

Deckenleuchte und Wandleuchte mit Struktur aus Metall Nickel satiniert.  
Schirm aus Mattglas.

Plafonnier et applique avec structure en métal nickel satiné.  
Abat-jour en verre mat.

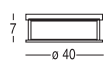
Plafones y applique con estructura en metal níquel satinado.  
Pantalla en vidrio opaco.

codice code	cavo elettrico cm electric cable cm	IMBALLO CM/PACKAGING CM SH = Shade ST = Structure	peso netto kg. net weight kg.	peso lordo kg. gross weight kg.	lampadina bulb	€ iva esclusa € tax not included
<b>0603-40</b>					 1x16W LED R7s 17 mm oppure/or  1 x max 200W R7s 117 mm Halo	<b>345,00</b>

Lampadina esclusa / Bulb not included



# C'hi Umberto Asnago 1999

Lampade con struttura in metallo nichel satinato. Diffusore esterno in vetro soffiato nei colori: argento, trasparente, bianco opalino, sabbia. Diffusore interno in vetro acidato. **Apparenti difetti dei vetri soffiati come bolle, variazione dei toni di colore o puntinature nell'argentatura sono da riconoscere come pregi della lavorazione a mano.**

Lamps with structure in nickel satin metal. Outer shade in blown glass in the following colours: silver, transparent, opal white, or sand. Inner shade in mat glass. **Apparent imperfections, such as bubbles, nuances in the glass colours or spots in the silver finish have to be recognised as qualities and signs of the hand made production.**









Leuchten mit Struktur aus Metall Nickel satiniert. Außenschirm aus geblasenem Glas in den folgenden Farben: Silber, Transparent, Opalweiß, Sand. Innenschirm aus Mattglas. **Scheinfehlern, wie Blasen, Farbnuancen oder Punkte in der Silberausführung müssen als Qualitäten und Zeichen einer Handwerksbearbeitung verstanden sein.**

Lampes avec structure en métal nickel satiné. Abat-jour extérieure en verre soufflé dans les couleurs: argent, transparent, blanc opale, sable. Abat-jour intérieure en verre mat. **Imperfections apparentes telles que des bulles, variations dans les nuances des couleurs ou points dans la finition argent doivent être reconnus comme signes du travail fait à main.**

Lámparas con estructura en metal níquel satinado. Difusor exterior en vidrio soplado en los colores: plata, transparente, opal blanco, arena. Difusor interior en vidrio opaco. **Aparentes defectos como burbujas, variaciones del color o puntos en el color plata, deben ser considerados como confirmación de la elaboración a mano.**







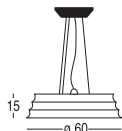

9907

Tavolo Table

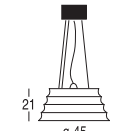

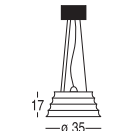

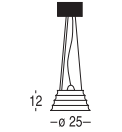
codice code	cavo elettrico cm electric cable cm	IMBALLO CM/PACKAGING CM SH = Shade ST = Structure	peso netto kg. net weight kg.	peso lordo kg. gross weight kg.	lampadina bulb	€ iva esclusa € tax not included
9907-03 LARGE	160	SH 55 x 55 x 35 h. ST 34 x 34 x 55 h.	5,5	7	 1 x 10W LED - E27 oppure/or	bianco-trasparente white-transparent <b>630,00</b>
					 1 x max 100W - E27 Halo	argento-sabbia silver-sand <b>740,00</b>
9907-02 MEDIUM	160	SH 44 x 44 x 29 h. ST 28 x 28 x 49 h.	2,5	4	 1 x 10W LED - E27 oppure/or	bianco-trasparente white-transparent <b>490,00</b>
					 1 x max 100W - E27 Halo	argento-sabbia silver-sand <b>595,00</b>
9907-01 SMALL	160	SH 31 x 31 x 32 h. ST 20 x 20 x 38 h.	1,2	1,6	 1 x 5W LED - E14 oppure/or	bianco-trasparente white-transparent <b>365,00</b>
					 1 x max 60W - E14 Halo	argento-sabbia silver-sand <b>430,00</b>
9907-10	200	SH 55 x 55 x 35 h. ST 36 x 36 x 184 h.	5,5	7	 1 x max 150W E27 Halo  Dimmer	bianco-trasparente white-transparent <b>795,00</b> argento-sabbia silver-sand <b>895,00</b>

Terra Floor

Lampadina esclusa / Bulb not included

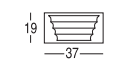
codice code	cavo elettrico cm electric cable cm	IMBALLO CM/PACKAGING CM SH = Shade ST = Structure	peso netto kg. net weight kg.	peso lordo kg. gross weight kg.	lampadina bulb	€ iva esclusa € tax not included	
<b>9907-24</b> MAXI	 15 ø 60 Non realizzabile in argento Not available in silver colour	200	SH 68 x 68 x 35 h.	4,4	7,2	3 x 10W LED - E27 oppure/or  3 x max 100W - E27 Halo 	bianco-trasparente white-transparent <b>870,00</b>
						ST 45 x 45 x 28 h.	1,5
<b>9907-23</b> LARGE	 21 ø 45	200	SH 55 x 55 x 35 h.	3,1	4,5	1 x 10W LED - E27 oppure/or  1 x max 100W - E27 Halo 	bianco-trasparente white-transparent <b>495,00</b>
						ST 31 x 31 x 32 h.	1,2
<b>9907-22</b> MEDIUM	 17 ø 35	200	SH 45 x 45 x 28 h.	2,5	3,3	1 x 10W LED - E27 oppure/or  1 x max 100W - E27 Halo 	bianco-trasparente white-transparent <b>420,00</b>
						ST 31 x 31 x 32 h.	1,2
<b>9907-21</b> SMALL	 12 ø 25	200	SH 31 x 31 x 32 h.	2,1	2,5	1 x 5W LED - E14 oppure/or  1 x max 60W - E14 Halo 	bianco-trasparente white-transparent <b>330,00</b>
						ST 31 x 31 x 32 h.	1,2

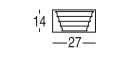
## Lampadina esclusa / Bulb not included

<b>9907-33</b> LARGE	 19 37	55 x 42 x 37 h.	2	3	1 x 16W LED R7s 117 mm 	bianco-trasparente white-transparent <b>395,00</b>
					1 x max 150W R7s 117 mm Halo 	argento-sabbia silver-sand <b>470,00</b>
<b>9907-31</b> SMALL	 14 27	45 x 45 x 28 h.	1,2	2	1 x 10W LED R7s 78 mm 	bianco-trasparente white-transparent <b>295,00</b>
					1 x max 60W R7s 78 mm Halo 	argento-sabbia silver-sand <b>360,00</b>

## Lampadina esclusa / Bulb not included

# China

Nicola Gallizia 2003/2007

Lampade con struttura in metallo tornito in lastra. Verniciato opaco nei colori: rosso, maron glacé, bronzo e rame. Verniciato lucido nei colori: bianco, nero o cromo. Disponibile anche in foglia oro.

La lampada da tavolo MAXI è disponibile solo nei colori bianco lucido, foglia oro, bronzo.

Lamps with metal structure. Matt varnished in the colours: red, maron glacé, bronze and copper. Glossy varnished in the colours: white, black or chrome. Available also in golden leaf.

**MAXI table lamp available only in the colours: glossy white, white, golden leaf, bronze.**

Lampen mit Struktur aus Metal. Matt lackiert in den Farben: rot, maron glacé, bronze oder kupferrot. Glänzendlackiert in den Farben: weiß, schwarz oder Chrom. Aus Blattgold auch erhältlich.

**MAXI Tischleuchte nur aus glänzendem weiß, Blattgold, Bronze.**

Lampes avec structure en métal. Verni mat dans les couleurs: rouge, maron glacé, bronze ou cuivre. Verni poli dans les couleurs: blanc, noir ou chrome. Disponible aussi en feuille d'or.











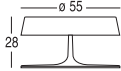

**La lampe à poser MAXI n'est pas disponible que dans les couleurs: blanc poli, feuille d'or, bronze.**

Lámparas con estructura en metal. Lacado opaco en los colores: rojo, maron glacé, bronzo o cobrizo. Lacado brillante en los colores: blanco, negro o cromado. Disponible también en pan de oro.

**Lámpara de mesa MAXI disponible solamente en los colores: blanco brillante, pan de oro, bronzo.**

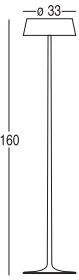
0308

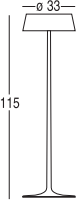
Tavolo Table

codice code		cavo elettrico cm electric cable cm	IMBALLO CM/PACKAGING CM SH = Shade ST = Structure	peso netto kg. net weight kg.	peso lordo kg. gross weight kg.	lampadina bulb	€ iva esclusa € tax not included
0308-04 MAXI		180	66 x 66 x 48 h.	9,5	12	 3 x max 100W E27 Halo	bianco lucido/glossy white <b>580,00</b>
						 Dimmer	bronzo-foglia oro bronze-golden leaf <b>860,00</b>
0308-00 MEDIUM		160	41 x 41 x 53 h.	3,7	5,3	 3 x max 40W E14 Halo	bianco-nero lucido glossy white-black <b>295,00</b>
						 Dimmer	rosso-m.glacé-bronzo-cromo rame-foglia oro red-m.glacé-bronze-chrome copper-golden leaf <b>440,00</b>
0308-01 SMALL		180	27 x 27 x 37 h.	2,2	3	 2 x 5W LED - E14 oppure/or	bianco-nero lucido glossy white-black <b>245,00</b>
						 2 x max 60W - E14 Halo	rosso-m.glacé-bronzo-cromo rame-foglia oro red-m.glacé-bronze-chrome copper-golden leaf <b>380,00</b>
0308-12 HIGH		200	41 x 41 x 186 h.	5,7	8,3	 3 x max 60W E14 Halo	bianco-nero lucido glossy white-black <b>390,00</b>
						 Dimmer	rosso-m.glacé-bronzo-cromo rame-foglia oro red-m.glacé-bronze-chrome copper-golden leaf <b>545,00</b>
0308-11 LOW		200	41 x 41 x 137 h.	5	7	 3 x max 60W E14 Halo	bianco-nero lucido glossy white-black <b>360,00</b>
						 Dimmer	rosso-m.glacé-bronzo-cromo rame-foglia oro red-m.glacé-bronze-chrome copper-golden leaf <b>495,00</b>

Lampadina esclusa / Bulb not included

# Ciak Umberto Asnago 2015

Lampada da terra orientabile con struttura in metallo ed espanso termoplastico.

Finiture:

- Versione laccata: soft touch nei colori bianco o antracite
- Versione cuoio: parte inferiore cuoio beige, tortora o testa di moro parte superiore laccata colore tabacco o madreperla

Adjustable floor lamp with metal and thermoplastic expansion structure.

Finishes:

- Varnished version: soft touch in the colours white or anthracite
- Leather version: bottom part in beige, tortora or testa di moro Upper part varnished in tobacco or pearl

Drehbare Stehleuchte mit Struktur aus thermoplastische Expansion

- Lackiert in soft touch weiß oder antrazit
- Aus Leder: Fuß aus beige, tortora oder testa di moro Leder und Struktur aus tabacco oder perlmuttfarben Metall

Lampadaire orientable avec structure en expansion thermoplastique



- Lacqué en soft touch blanc ou anthracite
- En cuir: parte inferiore en cuir beige, tortora ou testa di moro et parte superiore en metal tabacco ou nacre

Lámpara de pie orientable con estructura de metal y termoplástico expandido

- Acabados
- Versión lacada: "soft touch" en colores blanco o antracita
- Versión cuero: parte inferior cuero beige, tórtola o testa di moro parte superior lacada color tabaco o madreperla.

1503

Terra Floor

codice code	cavo elettrico cm electric cable cm	IMBALLO CM/PACKAGING CM SH = Shade ST = Structure	peso netto kg. net weight kg.	peso lordo kg. gross weight kg.	lampadina bulb	€ iva esclusa € tax not included
1503-10	200	110 x 35 x 170 h.	18	22	<p>Led integrato non sostituibile/ Led included not replaceable</p>  <p>15W - 24V LED 3000K</p>  Dimmer	<p>soft touch</p> <p><b>1.250,00</b></p> <p>cuoio leather</p> <p><b>1.550,00</b></p>

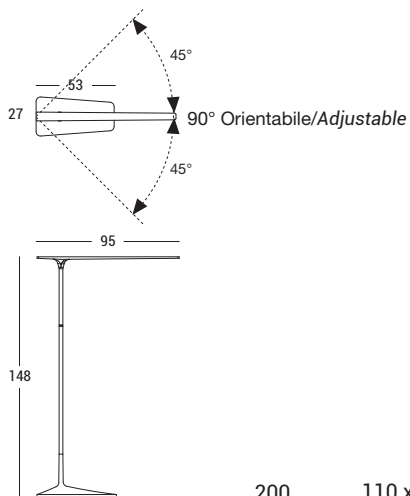

# Cryon

Paolo Mapelli 2011

Lampade a sospensione con struttura in metallo verniciato bianco. Diffusori in vetro: bianco lucido, argento/ bianco, oro rosa/bianco

Pendants with structure in white varnished metal. Shades in glass: white glossy, silver/white, pink gold/white.





Hängeleuchten mit Struktur aus weissem lackiertem Metall. Schirmen aus Glas: glänzendem Weiss, Silber/ Weiss, Rosengold/Weiss.

Suspensions avec structure en métal verni blanc. Diffuseurs en verre: blanc poli, argent/blanc, rose/blanc.

Lámparas de suspensión con estructura en metal pintado blanco. Difusores en cristal blanco brillante, plata/blanco, oro rosa/blanco

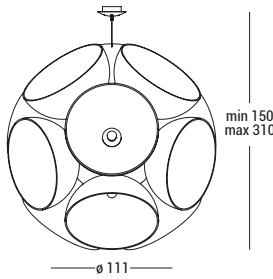
1012

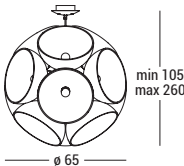
Sospensioni Pendant

codice code	cavo elettrico cm electric cable cm	IMBALLO CM/PACKAGING CM SH = Shade ST = Structure	peso netto kg. net weight kg.	peso lordo kg. gross weight kg.	lampadina bulb	€ iva esclusa € tax not included
<b>1012-22</b> LARGE		<b>wooden pallets</b> SH 105 x 105 x 95 h. <b>box</b> ST 65 x 65 x 65 h.	68	100	 12 x 16W LED E27 globo oppure/or <b>Lampadina inclusa/ Bulb included</b>  12 x max 25W E27 Fluo	bianco/white <b>4.450,00</b> argento/oro rosa silver/pink gold <b>6.530,00</b>
<b>1012-21</b> SMALL		<b>SH + ST wooden pallets</b> 120 x 80 x 75 h. <b>2 boxes:</b> 65 x 65 x 65 h. 50 x 50 x 50 h.	18	36	<b>Lampadina inclusa/ Bulb included</b>  12 x max 11W E14 Fluo	bianco/white <b>2.395,00</b> argento/oro rosa silver/pink gold <b>3.655,00</b>

 = lampadina compresa solo per 230 V~ (NO 110V~)  
bulb included only for 230V~ (NOT 110V~)

# Glo Carlo Colombo 2009/2015

Lampade con struttura in metallo cromato lucido e vetro borosilicato. Diffusore esterno: trasparente, iridescente, oro, argento, oro rosa, nero, 4ever e Total White. Diffusore interno sabbiato. Rosone a soffitto in titanio e bianco.

**A RICHIESTA:**  
- estensione cablaggio elettrico € 12,00/mt + IVA.

Lamps with chromed metal structure and borosilicate glass. Outer shade transparent, gold, silver, iridescent, pink gold, black, 4ever and Total White. Inner shade sandblasted. Canopy in titanium and white.

**ON DEMAND:**  
- longer electrical cable € 12,00/mt

Leuchten mit Struktur aus glänzendem verchromtem Metall und Borosilikatglas. Außenschirm transparent, Regenbogenfarben schillernd, golden, silber, Rosengold, schwarz, 4ever und Total White. Innenschirm mat. Deckbefestigung aus Titanium oder Weiß.

**AUF VERLANGEN:**  
- längere elektrische kabel € 12,00/mt

Lampes avec structure en métal chromé poli et verre borosilicate. Abajour extérieur transparent, iridescent, or, argent, or rose, noir, 4ever et Total White. Intérieure sablé. Rosette en titanium ou blanc.



**SUR DEMANDE:**  
- câble électrique plus long € 12,00/mt.

Lámparas con estructura en metal cromado brillante y cristal borosilicado. Difusor exterior transparente, iridescente, oro, plata, oro rosa, negro, 4ever y Total White. Difusor interno al ácido. Rosetón en titanium o blanco.

**A PEDIDO:**  
- cable eléctrico más largo € 12,00/mt.

0811

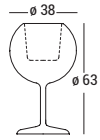
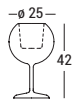
Tavolo Table

codice code		cavo elettrico cm electric cable cm	IMBALLO CM/PACKAGING CM SH = Shade ST = Structure	peso netto kg. net weight kg.	peso lordo kg. gross weight kg.	lampadina bulb	€ iva esclusa € tax not included
<b>0811-03</b> LARGE		180	49 x 49 x 78 h.	3,4	6,3	1 x max 100W - E27 Halo Dimmer	trasparente/transparent <b>795,00</b> colorato - total white coloured - total white <b>995,00</b> 4ever <b>1.155,00</b>
<b>0811-01</b> MEDIUM		180	37 x 37 x 62 h.	1,6	3,4	1 x 5W LED - E14 oppure/or 1 x max 60W - E14 Halo	trasparente/transparent <b>395,00</b> colorato - total white coloured - total white <b>510,00</b> 4ever <b>585,00</b>
<b>0811-00</b> MINI		180	20 x 20 x 38 h.	0,49	1,0	1 x 3W LED - G9 oppure/or 1 x max 28W - G9 Halo	trasparente/transparent <b>195,00</b> colorato - total white coloured - total white <b>265,00</b> 4ever <b>315,00</b>

Terra Floor

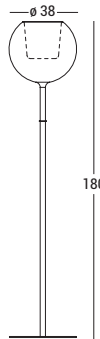
<b>0811-10</b>		250	SH 49 x 49 x 98 h. ST 49 x 49 x 141 h.	5,0 9,5	8,0 13,0	1 x max 150W E27 Halo Dimmer	struttura cromo vetro trasparente glossy chrome structure transparent glass <b>1.150,00</b> struttura bianca vetro total white white laquered structure total white glass <b>1.250,00</b> struttura cromo vetro colorato glossy chrome structure coloured glass <b>1.350,00</b> struttura oro vetro oro golden structure golden glass <b>1.450,00</b> struttura oro vetro 4ever golden structure 4ever glass <b>1.495,00</b>
----------------	---	-----	---	------------	-------------	---------------------------------	--

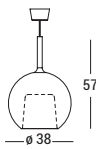
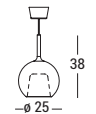
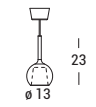
codice code	cavo elettrico cm electric cable cm	IMBALLO CM/PACKAGING CM SH = Shade ST = Structure	peso netto kg. net weight kg.	peso lordo kg. gross weight kg.	lampadina bulb	€ iva esclusa € tax not included	
<b>0811-23</b> LARGE		200	49 x 49 x 78 h.	3,3	6,2	1 x 10W LED - E27 oppure/or 1 x max 100W - E27 Halo	trasparente/transparent <b>730,00</b> colorato - total white coloured - total white <b>875,00</b> 4ever <b>980,00</b>
<b>0811-21</b> MEDIUM		200	37 x 37 x 62 h.	1,5	3,3	1 x 5W LED - E14 oppure/or 1 x max 60W - E14 Halo	trasparente/transparent <b>385,00</b> colorato - total white coloured - total white <b>495,00</b> 4ever <b>570,00</b>
<b>0811-20</b> MINI		200	20 x 20 x 38 h.	0,43	1,0	1 x 3W LED - G9 oppure/or 1 x max 28W - G9 Halo	trasparente/transparent <b>195,00</b> colorato - total white coloured - total white <b>255,00</b> 4ever <b>295,00</b>

## Esempi di installazione/Installation examples

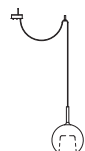
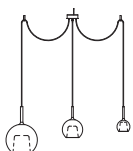
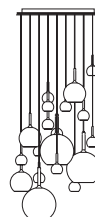
Singola  
SingleSingola con decentramento  
Single decentralizedMultiple con decentramento  
Multiple decentralizedComposizione con piastra  
Cluster with plate

Piastre e rosoni pag. 75  
Plates and canopies pag. 75

# Glo special edition

Lampada a sospensione realizzata in vetro borosilicato con diffusore interno sabbato ed esterno oro fumato nero. Cablaggio elettrico in maglia metallica oro e rosone a soffitto nero. Utilizzabile solo come elemento singolo.

Pendant made of borosilicate glass with sandblasted inner shade and outer shade in the finish melange gold/black. Wiring in gold metallic mesh and canopy in black metal. To be sell only as single element.

Hängeleuchte mit Außenschirm aus melange gold/schwarz Borosilikatglas und Innenschirm matt. Verkabelung aus goldem metallischem Netz und Deckbefestigung aus schwarzem Metall. Nur aus einzelne Lampe.

Suspension en verre borosilicate avec abat-jour sablé à l'intérieure et mélange or/noir à l'extérieure. Câblage électrique en maille métallique or et rosace en metal noir. Seulemente pour suspension individuelle.

Lámpara de suspensión realizada en vidrio borosilicado con difusor interior arenado y exterior oro degradé-negro. Cableado eléctrico de malla metálica oro y rosetón a techo negro. Utilizable solo como elemento individual (lámpara)

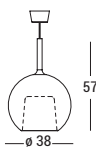
codice code	cavo elettrico cm electric cable cm	IMBALLO CM/PACKAGING CM SH = Shade ST = Structure	peso netto kg. net weight kg.	peso lordo kg. gross weight kg.	lampadina bulb	€ iva esclusa € tax not included	
<b>0811-23</b> LARGE		200	49 x 49 x 78 h.	3,3	6,2	1 x 10W LED - E27 oppure/or 1 x max 100W - E27 Halo	<b>995,00</b>

Lampadina esclusa / Bulb not included

# Jeï Jeï

Nicola Gallizia 2005

Lampada sospensione e applique.  
Struttura in metallo nichel satinato o bronzo con diffusori a braccio modulari grandi, medi e piccoli in vetro borosilicato trasparente (fumé, ambra, oro rosa solo su richiesta).

Trasformatore di sicurezza alloggiato nel rosone in acciaio, con vaso di copertura in vetro borosilicato.

Asta telescopica in acciaio satinato. Bracci di ricambio (uno per misura) forniti nell'imballo originale.

**A RICHIESTA:**

- Versione dimmerabile
- Asta su misura al costo

Pendant and wall lamps.  
Structure in nickel satin metal or bronze with modular large, medium and small arm shades in transparent borosilicate glass (fumé, amber or pink gold only on demand).

Safety transformer in the upper steely canopy, with covering shade in borosilicate glass.

Telescopic stem in satin steel.

Replacement arms (one for each measure) supplied in the original package.

**ON DEMAND:**

- Dimmerable version
- Custom size stem

Häng- und Wandlampen.  
Struktur aus Nickel satiniert oder bronze mit großen, mittleren und kleinen Modulare aus transparent Borosilikatglas (fumé, bernstein oder rosengold nur auf Wunsch).

Sicherheitstransformator in der Stahldeckbefestigung, mit Deckschirm aus Borosilikatglas.

Teleskopischstange aus satiniertem Stahl.

Austauscharme (ein für jedes Maß) mit der Originalverpackung geliefert.

**AUF VERLANGEN:**

- Ausführung für Dimmer
- Stange mit Sondermaß

Suspensions ou appliques.  
Structure en nickel satiné ou bronze avec diffuseurs à bras modulaires grands, moyens ou petits en verre borosilicate transparent (fumé, ambre or rose sur demande).

Transformateur de sûreté dans la calotte supérieure en acier, avec couverture en verre borosilicate. Tige télescopique en acier satiné. Bras de rechange (un pour chaque mesure) livrés dans l'emballage originale.

**SUR DEMANDE:**

- Version pour dimmer
- Tige sur mesure







Lámparas de techo y aplique.  
Estructura en metal níquel satinado o bronzo con difusores de brazo modulares grandes, medianos o pequeños en vidrio borosilicado transparente (fumé, ámbar, oro/rosa bajo pedido).

Transformador de seguridad en el roseton de acero, con cobertura de vidrio borosilicada. Barra telescópica en acero satinado.

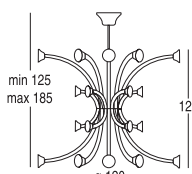
**A PEDIDO:**

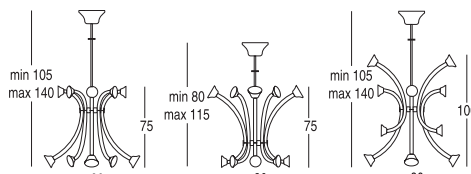
- Variante para dimmer
- Asta a medida

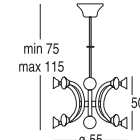



Sospensioni Pendant 0501

codice code	cavo elettrico cm electric cable cm	IMBALLO CM/PACKAGING CM SH = Shade ST = Structure	peso netto kg. net weight kg.	peso lordo kg. gross weight kg.	lampadina bulb	€ iva esclusa € tax not included		
<b>0501-24</b> MAXI 32 LUCI/LIGHTS		Set lampadine led/led bulbs set € 225,00 netto	bancale/pallet 80 x 120 x 184 h.	25	60	 G4 32x2W 12V Led	struttura nickel/ nickel structure	struttura bronz/ bronze structure
							trasparente transparent <b>5.995,00</b>	trasparente transparent <b>7.810,00</b>
							fumé/ambra fumé/amber <b>6.990,00</b>	fumé/ambra fumé/amber <b>8.995,00</b>
							oro-rosa pink-gold <b>8.530,00</b>	oro-rosa pink-gold <b>10.695,00</b>
<b>0501-22</b> MEDIUM 16 LUCI/LIGHTS		Possibilità di invertire la disposizione dei bracci Possibility of changing the position of the arms Set lampadine led/led bulbs set € 122,00 netto	bancale/pallet 80 x 120 x 132 h.	14	26,5	 G4 16x2W 12V Led	trasparente transparent <b>3.465,00</b>	trasparente transparent <b>4.400,00</b>
							fumé/ambra fumé/amber <b>3.810,00</b>	fumé/ambra fumé/amber <b>4.865,00</b>
							oro-rosa pink-gold <b>4.595,00</b>	oro-rosa pink-gold <b>5.880,00</b>
							trasparente transparent <b>3.105,00</b>	trasparente transparent <b>3.975,00</b>
<b>0501-21</b> SMALL 16 LUCI/LIGHTS		Set lampadine led/led bulbs set € 122,00 netto	bancale/pallet 80 x 120 x 80 h.	13,5	21,5	 G4 16x2W 12V Led	trasparente transparent <b>3.445,00</b>	trasparente transparent <b>4.335,00</b>
							fumé/ambra fumé/amber <b>3.445,00</b>	fumé/ambra fumé/amber <b>4.335,00</b>
							oro-rosa pink-gold <b>4.190,00</b>	oro-rosa pink-gold <b>5.255,00</b>
							trasparente transparent <b>3.105,00</b>	trasparente transparent <b>3.975,00</b>

## Lampadina esclusa / Bulb not included

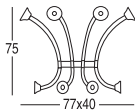

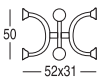
Set lampadine solo per 230V (no 110V) / Bulbs set for 230V only (not 110V)



codice code	cavo elettrico cm electric cable cm	IMBALLO CM/PACKAGING CM SH = Shade ST = Structure	peso netto kg. net weight kg.	peso lordo kg. gross weight kg.	lampadina bulb	€ iva esclusa € tax not included	
						struttura nickel/ nickel structure	struttura bronzo/ bronze structure
<b>0501-33</b> LARGE 8 LUCI/LIGHTS		2 box da 80 x 40 x 34 h.	6	10,5	 G4 8x2W 12V Led	trasparente transparent <b>1.695,00</b>	trasparente transparent <b>2.175,00</b>
						fumè/ambra fumè/amber <b>1.875,00</b>	fumè/ambra fumè/amber <b>2.410,00</b>
						oro-rosa pink-gold <b>2.380,00</b>	oro-rosa pink-gold <b>2.950,00</b>
<b>0501-30</b> SMALL 6 LUCI/LIGHTS		56 x 40 x 34 h.	4	6	 G4 6x2W 12V Led	trasparente transparent <b>1.140,00</b>	trasparente transparent <b>1.390,00</b>
						fumè/ambra fumè/amber <b>1.275,00</b>	fumè/ambra fumè/amber <b>1.615,00</b>
						oro-rosa pink-gold <b>1.590,00</b>	oro-rosa pink-gold <b>1.980,00</b>

Lampadina esclusa / Bulb not included

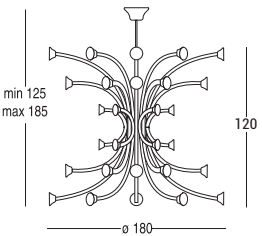
# Jeï Jeï Super maxi

codice code	cavo elettrico cm electric cable cm	IMBALLO CM/PACKAGING CM SH = Shade ST = Structure	peso netto kg. net weight kg.	peso lordo kg. gross weight kg.	lampadina bulb	€ iva esclusa € tax not included	
						struttura nickel/ nickel structure	struttura bronzo/ bronze structure
<b>0501-50</b> SUPER MAXI 48 LUCI/LIGHTS		SH 9 box da 36 x 120 x 65 h.			 G4 48x2W 12V Led	trasparente transparent <b>10.485,00</b>	trasparente transparent <b>13.390,00</b>
						fumè/ambra fumè/amber <b>11.750,00</b>	fumè/ambra fumè/amber <b>15.015,00</b>
						oro-rosa pink-gold <b>13.995,00</b>	oro-rosa pink-gold <b>17.730,00</b>

Lampadina esclusa / Bulb not included

Set lampadine solo per 230V (no 110V) / Bulbs set for 230V only (not 110V)

# Je Suis

Carlo Colombo 2015

Lampada da terra e tavolo con base realizzata in: legno rovere, legno tinto antracite o in marmo bianco di Carrara. Diffusore girevole 360° in vetro soffiato bicolore trasparente/argento o bianco/argento.

Floor and table lamp with base in: oak, stained anthracite wood or Carrara white marble. 360° turning bicolor blown glass shade in transparent/silver or white/silver

Ste- und Tischleuchte mit Struktur aus Eiche, antrazitfarbig Holz oder weissem Carrara Marmor. 360° drehbaren Schirm aus geblasenem Glas zweifarbig: transparentem/silber oder weiss/silber.

Lampadaire ou lampe à poser avec structure en bois chene ou teinte anthracite ou en marble de Carrara blanc. Abat-jour pivotant 360° en verre soufflé dans 2 couleurs: transparent/argent ou blanc/argent.

Lámpara de pie y sobremesa con base realizada en: madera de roble, madera tintada antracita o mármol blanco Carrara. Difusor en cristal soplado en versión bicolor transparente/plata o blanco/plata. El difusor gira 360°.

1502

Tavolo Table

codice code	cavo elettrico cm electric cable cm	IMBALLO CM/PACKAGING CM SH = Shade ST = Structure	peso netto kg. net weight kg.	peso lordo kg. gross weight kg.	lampadina bulb	€ iva esclusa € tax not included
1502-03	200	SH 50 x 50 x 50 h.	2	4,5	Led integrato non sostituibile/ Led included not replaceable	legno wood
		ST 46 x 35 x 35 h.	6	15	1x17,5W - LED 3000 K	marmo marble
			18	27	Dimmer	2.100,00

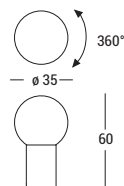

Terra Floor

1502-10	200	SH 50 x 50 x 50 h.	2	4,5	Led integrato non sostituibile/ Led included not replaceable	legno wood
		ST 38 x 43 x 130 h.	31	51	1x17,5W - LED 3000 K	marmo marble
			135	155	Dimmer	4.500,00

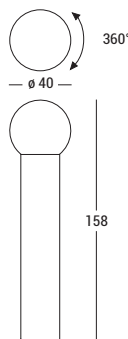

# Juliette

Carlo Colombo 2013

Lampade con struttura in metallo nichel nero lucido o verniciata bianco opaco. Base in marmo nei colori: bianco di Carrara o nero Marquinia.

Lamps with structure in glossy black nickel or mat white varnished metal. Base in white Carrara or black Marquinia marble.







Lampen mit Struktur aus glänzendem schwarzem Nickel oder matt weissem lackiertem Metall. Sockel aus weiss Carrara oder schwarz Marquinia Marmor.

Lampes avec structure en métal nickel noir poli ou verni blanc mat. Base en marbre: blanc de Carrara ou noir Marquinia.

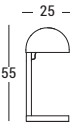
Lámparas con estructura en metal níquel negro brillante o lacada mate en el colore: blanco. Base en marmol: en color blanco de Carrara o negro Marquina.

1305

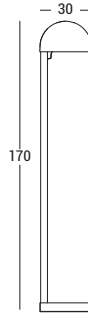
Tavolo Table

codice code		cavo elettrico cm electric cable cm	IMBALLO CM/PACKAGING CM SH = Shade ST = Structure	peso netto kg. net weight kg.	peso lordo kg. gross weight kg.	lampadina bulb	€ iva esclusa € tax not included
1305-03 LARGE		160	BA 40 x 40 x 12 h.	5	8	1 x 5W LED - E14 oppure/or  1 x max 8W E14 Fluo	1.130,00
			ST 32 x 32 x 62 h.	8	9		
1305-01 SMALL		160	48 x 48 x 24 h.	2,8	3,5	1 x 5W LED - G9 oppure/or  1 x max 33W - G9 Halo	740,00
1305-10		180	BA 40 x 40 x 12 h.	6	10	1 x 10W LED - E27 oppure/or  1 x max 15W E27 Fluo	1.790,00
			ST 38 x 38 x 185 h.	16	20		

Terra Floor

Lampadina esclusa / Bulb not included

# Kaskade Umberto Asnago 2011

Lampade a sospensione e plafoniera, struttura in acciaio supermirror e bronzo. Diffusori in vetro borosilicato trasparente, modulari e componibili grandi, medi e piccoli.

Pendant and ceiling lamps, structure in bronze or supermirror steel. Modular large, medium and small shades in transparent borosilicate glass.

Deck- und Wandleuchten mit Struktur aus Bronze oder supermirror Stahl. Größe, mittelgröße und kleine. Modulararmen aus transparentem Borosilikatglas.

Plafonniers et appliqués avec structure en métal bronze ou acier supermirror. Diffuseurs à bras modulaires grands, moyens ou petits en verre borosilicate transparent.

Lámparas de suspensión y plafón, estructura en metal bronzo o acero supermirror. Difusores de cristal borosilicado transparente, modulares y componibles, grandes, medianos y pequeños.

1105

Sospensioni-plafoniere Pendant-ceiling

codice code	cavo elettrico cm electric cable cm	IMBALLO CM/PACKAGING CM SH = Shade ST = Structure	peso netto kg. net weight kg.	peso lordo kg. gross weight kg.	lampadina bulb	€ iva esclusa € tax not included
<b>1105-23-20</b> ROUND 13 LUCI/LIGHTS			8,2	13,9	13 x 7W LED - GU10 oppure/or <b>Lampadina inclusa</b> Bulb included	acciaio supermirror/ supermirror steel <b>5.995,00</b>
						13x75W GU10 Halo bronzo/bronze <b>7.990,00</b>
<b>1105-21-00</b> ROUND 7 LUCI/LIGHTS			5	9	7 x 7W LED - GU10 oppure/or <b>Lampadina inclusa</b> Bulb included	acciaio supermirror/ supermirror steel <b>3.495,00</b>
						7x75W GU10 Halo bronzo/bronze <b>4.510,00</b>
<b>COMPOSIZIONE</b> TRIS VETRI GLASSES COMPOSITION		<b>A LARGE</b> A1: arm lenght 62 cm A2: arm lenght 66 cm A3: arm lenght 70 cm		<b>B MEDIUM</b> B1: arm lenght 37 cm B2: arm lenght 41 cm B3: arm lenght 45 cm		<b>C SMALL</b> C1: arm lenght 25 cm C2: arm lenght 29 cm C3: arm lenght 33 cm

= lampadina compresa solo per 230 V~(NO 110V~)  
bulb included only for 230V~ (NOT 110V~)

# Kelly 1995

Lampada realizzata interamente in legno tinto miele, wengé o laccata bianca lucida. Diffusore nei tessuti della collezione.

Lamp with honey colour, wengé or glossy white lacquered structure, totally in stained wood. Shade in the fabrics of the collection.



Leuchte mit ganzer Struktur aus Hönig- und Wengéfarbigholz oder glänzendem Weißlackiertem Holz. Schirm in den Stoffen der Kollektion.

Lampe en bois teinté miel, wengé ou laqué blanc poli. Abat-jour dans les tissus de la collection.

Lámpara realizada totalmente en madera tintada miel, wengé o lacado blanco brillante. Difusor en los tejidos de la colección.

9511

Terra Floor

codice code	cavo elettrico cm electric cable cm	IMBALLO CM/PACKAGING CM SH = Shade ST = Structure	peso netto kg. net weight kg.	peso lordo kg. gross weight kg.	lampadina bulb	€ iva esclusa € tax not included
9511-16	200	SH 68 x 68 x 35 h.	0,4	3,2	 1 x 10W LED - E27 oppure/or  1 x max 100W - E27 Halo/Fluo	miele - wengé honey - wengé <b>1.095,00</b>
		ST 48 x 48 x 160 h.	12,2	17		bianca white <b>1.245,00</b>

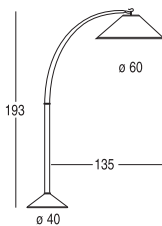

Snodo orientabile a 180°  
Adjustable joint 180°

Lampadina esclusa / Bulb not included

# Kimilla

Umberto Asnago 2003

Lampade con struttura in metallo nichel satinato. Diffusore in vetro soffiato trasparente/acidato o fumé. Appliques solo vetro trasparente/acidato.

Lamps with metal structure in nickel satin. Shade in blown glass: transparent/mat or fumé. Wall lamps only transparent/mat shade.







Lampen mit Struktur aus Metall Nickel satiniert. Schirm aus geblasenem Glas: Transparent/Matt oder Fumé. Wandleuchten nur aus transparent/matt geblasenem Glas.

Lampes avec structure en métal nickel satiné. Abat-jour en verre soufflé: transparent/mat ou fumé. Appliques seulement en verre soufflé transparent/mat.

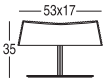

Lámparas con estructura en metal niquelado satinado. Difusor de cristal soplado transparente/al ácido o fumé. Appliques sólo cristal transparente/al ácido.

0312



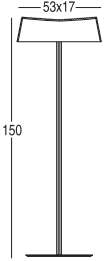

Tavolo Table

codice code		cavo elettrico cm electric cable cm	IMBALLO CM/PACKAGING CM SH = Shade ST = Structure	peso netto kg. net weight kg.	peso lordo kg. gross weight kg.	lampadina bulb	€ iva esclusa € tax not included
<b>0312-03</b> LARGE		160	68 x 68 x 35 h.	7	9,8	 2 x max 60W E27 Halo  Dimmer	<b>650,00</b>
<b>0312-01</b> SMALL		160	45 x 45 x 28 h.	3,5	4,3	 1 x max 60W G9 Halo  Dimmer	<b>380,00</b>

Terra Floor

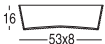
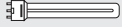
<b>0312-10</b>		200	SH 31 x 31 x 82 h. ST 30 x 60 x 176 h.	3 6,7	4 8,5	 2 x max 100W E27 Halo  Dimmer	<b>815,00</b>
----------------	--	-----	---	----------	----------	---	---------------

Applique Wall

<b>0312-33</b> LARGE	solo vetro trasparente/acidato only in transparent/mat shade 		68 x 68 x 35 h.	3,4	4,4	 1 x max 36W Dulux-2G11 Fluo	<b>425,00</b>
<b>0312-31</b> SMALL	solo vetro trasparente/acidato only in transparent/mat shade 		31 x 31 x 32 h.	1,4	2	 1 x 5W LED - G9 oppure/or  1 x max 60W - G9 Halo	<b>235,00</b>

Lampadina esclusa / Bulb not included

# Klint

## Umberto Asnago 2013

Lampade da tavolo realizzate in tondino di vetro trasparente, con base in bronzo e nichel satinato. Doppia accensione a led.

Table lamps with structure in transparent glass rod and base in bronze and satin nickel metal. Double led lighting.













Tischleuchten mit Struktur aus transparenten Glasbarren und Sockel aus glänzendem bronze oder satiniertem Nickel Metall. Doppelte Led-Beleuchtung.

Lampes à poser avec structure en barres de verre transparent et pied en bronze et nickel satiné. Allumage double par led.

Lámparas de sobremesa realizada en barra de cristal transparente. Base en bronce y níquel satinado. Doble encendido led.

1301

Tavolo Table

codice code	cavo elettrico cm electric cable cm	IMBALLO CM/PACKAGING CM SH = Shade ST = Structure	peso lordo kg. gross weight kg.	lampadina bulb	€ iva esclusa € tax not included
<b>1301-03</b> LARGE 	180	40 x 40 x 60 h.	4 5	Led integrato non sostituibile/ Led included not replaceable   =  =  Led 14W - 3200K  Led 17W - 3000K	<b>990,00</b>
<b>1301-01</b> SMALL 	180	27 x 27 x 52 h.	2,4 3,2	Led integrato non sostituibile/ Led included not replaceable   =  =  Led 7W - 3200K  Led 4W - 3000K	<b>480,00</b>

# Kori Umberto Asnago 1999

Lampade con base in legno ebano, bronzo, cuoio (della collezione). Diffusore esterno in vetro soffiato trasparente e interno opalino bianco.

Lamps with base in ebony wood, bronze or leather (among the collection). Outer shade in transparent blown glass, inner shade in blown opal white glass.







Lampen mit Sockel aus Ebenholz, Bronze oder Leder (von der Kollektion). Außenschirm aus transparentem geblasenem Glas und Innenschirm aus geblasenem opalweiß Glas.

Lampes avec base en bois d'ébène, bronze ou cuir (dans la collection). Abat-jour en verre soufflé transparent à l'extérieur et en verre soufflé opalin blanc à l'intérieur.

Lámparas con base en madera de ébano, bronce y cuero (de la colección). Difusor exterior de vidrio soplado transparente e interior opal blanco.

9913

Tavolo Table

codice code		cavo elettrico cm electric cable cm	IMBALLO CM/PACKAGING CM SH = Shade ST = Structure	peso netto kg. net weight kg.	peso lordo kg. gross weight kg.	lampadina bulb	€ iva esclusa € tax not included
<b>9913-03</b> LARGE		160	SH 55 x 42 x 37 h. ST 55 x 55 x 35 h.	6,5 2	7,5 3,3	 2 x 5W LED - E14 oppure/or  2 x max 60W - E14 Halo	legno ebano/ebony wood <b>790,00</b> cuoio/leather <b>910,00</b> bronzo/bronze <b>985,00</b>
<b>9913-01</b> SMALL		160	51 x 51 x 53 h.	4,4	8,2	 1 x 5W LED - E14 oppure/or  1 x max 60W - E14 Halo	legno ebano/ebony wood <b>570,00</b> cuoio/leather <b>665,00</b> bronzo/bronze <b>695,00</b>

Lampadina esclusa / Bulb not included



# Labo Daniel Debiasi e Federico Sandri 2013

Lampade con struttura in metallo nichel nero lucido o bronzo. Stelo e diffusore in vetro borosilicato nei colori: trasparente, fumo.

Lamps with structure in glossy black nickel metal or bronze. Stem and shade in borosilicate glass in the colours transparent, fumé.









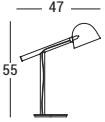

Lampen mit Struktur aus glänzendem schwarzem Nickel oder Bronze. Ständer und Schirm aus Borosilikatglas in Farben transparent, fumé.

Lampes avec structure en métal nickel noir poli ou bronze. Pied et abat-jour en verre borosilicate transparent, fumé.

Lámparas con estructura en metal níquel negro brillante o bronzo. Fuste y difusor en cristal borosilicado en los colores transparente, humo.

1306

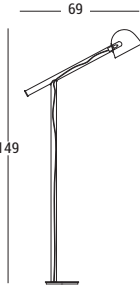
Tavolo Table

codice code		cavo elettrico cm electric cable cm	IMBALLO CM/PACKAGING CM SH = Shade ST = Structure	peso netto kg. net weight kg.	peso lordo kg. gross weight kg.	lampadina bulb	€ iva esclusa € tax not included
1306-03 LARGE		160	63 x 60 x 25 h.	6	7,3	 1 x 5W LED - G9 oppure/or  1 x max 33W - G9 Halo	Vetro trasparente Transparent glass <b>830,00</b>  Vetro fumo Fumé glass <b>910,00</b>
						 1 x max 20W 12V G4 Halo	Vetro trasparente Transparent glass <b>565,00</b>  Vetro fumo Fumé glass <b>610,00</b>
1306-01 SMALL		160	50 x 50 x 25 h.	2,3	3,5	 1 x 5W LED - G9 oppure/or  1 x max 42W - G9 Halo	Vetro trasparente Transparent glass <b>1.250,00</b>  Vetro fumo Fumé glass <b>1.395,00</b>
						 1 x max 20W 12V G4 Halo	Vetro trasparente Transparent glass <b>565,00</b>  Vetro fumo Fumé glass <b>610,00</b>
1306-10		180	BA 39 x 39 x 22 h.	6	10	 1 x 5W LED - G9 oppure/or  1 x max 42W - G9 Halo	Vetro trasparente Transparent glass <b>1.250,00</b>  Vetro fumo Fumé glass <b>1.395,00</b>
			SH 30 x 82 x 160 h.	16	21,5		

Lampadina esclusa / Bulb not included

# Lula

Umberto Asnago 2015

Lampade con struttura in metallo nei colori: oro satinato o laccato tabacco. Diffusore in vetro soffiato bianco.

Lamps with metal structure in the colours: satin gold or tobacco varnished. Shade in blown white glass.



Ste- und Tischleuchte mit Struktur aus golden satinierten Metall oder tabacco lackiert. Schirm aus weissem geblasenem Glas.

Lampadaire ou lampe à poser avec structure en metal doré satiné ou lacqué dans le couleur tabacco. Abat-jour en verre soufflé blanc.

Lámpara de pie y sobremesa con estructura en metal en colores: oro satinado o lacado tabaco. Difusor en cristal soplado blanco.

1505

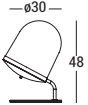
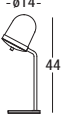
Tavolo Table

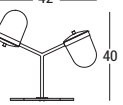
codice code		cavo elettrico cm electric cable cm	IMBALLO CM/PACKAGING CM SH = Shade ST = Structure	peso netto kg. net weight kg.	peso lordo kg. gross weight kg.	lampadina bulb	€ iva esclusa € tax not included
<b>1505-03</b> LARGE		200	SH 40 x 40 x 53 h.	2,5	3,5	1 x 105W - E27 Halo Dimmer	tabacco tobacco <b>940,00</b>
			ST 36 x 36 x 46 h.	5	7		oro satinato/ satin gold <b>970,00</b>
<b>1505-02</b> SMALL HIGH		200	45 x 45 x 30 h.	3	5	1 x 4W LED - E14 oppure/or 1 x 42W - E14 Halo/Fluo	tabacco tobacco <b>460,00</b>
							oro satinato/ satin gold <b>480,00</b>
<b>1505-01</b> SMALL LOW		200	45 x 45 x 30 h.	3	5	1 x 4W LED - E14 oppure/or 1 x 42W - E14 Halo/Fluo	tabacco tobacco <b>430,00</b>
							oro satinato/ satin gold <b>450,00</b>
<b>1505-04</b> DOUBLE		200	55 x 55 x 32,5 h.	4	6	2 x 4W LED - E14 oppure/or 2 x 42W - E14 Halo/Fluo	tabacco tobacco <b>950,00</b>
							oro satinato/ satin gold <b>990,00</b>

Terra Floor

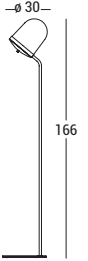
<b>1505-10</b>		200	SH 31 x 31 x 32 h.	1,5	2,5	1 x 70W - E27 Halo Dimmer	tabacco tobacco <b>1.090,00</b>
			ST 40 x 40 x 185 h.	6	8		oro satinato/ satin gold <b>1.150,00</b>

# Luume

Umberto Asnago 2003

Lampade con struttura in metallo cromato lucido. Diffusore in vetro borosilicato trasparente con fascia centrale sabbiata a schermo della lampadina.

Lamps with glossy chromed metal structure. Shade in transparent borosilicate glass with central sandblasted band to hide the bulb.



Lampen mit Struktur aus glänzendem verchromten Metall. Schirm aus transparentem Borosilikatglas mit zentralem Mattband, um die Glühbirne zu verstecken.

Lampes avec structure en métal chromé poli. Abat-jour en verre borosilicate transparent avec bande centrale sablée à couverture de l'ampoule.

Lámparas con estructura en metal cromado brillante. Difusor en vidrio borosilicado transparente con zona central matizada para ocultar el bulbo.



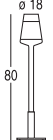

0316

Tavolo Table



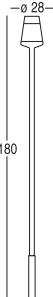

codice code		cavo elettrico cm electric cable cm	IMBALLO CM/PACKAGING CM SH = Shade ST = Structure	peso netto kg. net weight kg.	peso lordo kg. gross weight kg.	lampadina bulb	€ iva esclusa € tax not included
0316-03		160	SH 30 x 30 x 100 h. ST 31 x 31 x 62 h.	1 1,8	2,5 2,8	1 x max 60W E14 Halo  Dimmer	555,00

Lampadina esclusa / Bulb not included

Terra Floor

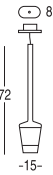
0316-10		200	SH 32 x 32 x 190 h. ST 32 x 32 x 190 h.	1,8 4,2	4 6,3	Lampadina inclusa/ Bulb included   1 x max 150W B15 Halo  Dimmer	755,00
---------	---	-----	--	------------	----------	--	--------

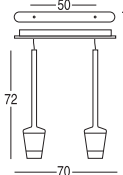
Sospensioni Pendant

0316-25 1 LUCE 1 LIGHT		200	SH 30 x 30 x 100 h. ST 31 x 31 x 32 h.	1 0,3	2,5 0,7	Lampadina inclusa/ Bulb included   1 x max 150W B15 Halo	415,00
0316-26 2 LUCI 2 LIGHTS		200	2 box da SH 30 x 30 x 100 h. ST 30 x 30 x 80 h.	2 1,4	5 2,2	Lampadina inclusa/ Bulb included   2 x max 150W B15 Halo	765,00

 = lampadina compresa solo per 230 V~ (NO 110V~)  
bulb included only for 230V~ (NOT 110V~)

# Loop

Umberto Asnago 2008

Lampada con base in nickel satinato e struttura rivestita in cuoio.

Finitura:  
• **cuoio** tinta unita o bicolore: bianco, nero, testa di moro, beige, tortora, avorio.

Lamp with base in satin nickel metal and structure covered with leather.

Finishes:  
• **leather** one colour or two colours: white, black, testa di moro, beige, tortora, ivory.

Lampe mit Sockel aus satiniertem Nickel Metall und Struktur bezogen mit Leder.

Ausführung:  
• **Leder** einfarbig oder zweifarbig: Weiß, Schwarz, Testa di moro, Beige, Tortora, Elfenbein.

Lampe avec base en métal nickel satiné et structure recouverte en cuir.



Finition:  
• **cuir** teinte unie ou bicolore: blanc, noir, testa di moro, beige, tortora, ivoire.

Lámparas con base en metal níquel satinado y estructura revestida en cuero.

Acabado:  
• **cuero** color único y bicolor: blanco, negro, testa di moro, beige, tortora, marfil.

0805

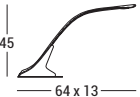
Tavolo Table

codice code	cavo elettrico cm electric cable cm	IMBALLO CM/PACKAGING CM SH = Shade ST = Structure	peso netto kg. net weight kg.	peso lordo kg. gross weight kg.	lampadina bulb	€ iva esclusa € tax not included
0805-00		130	31 x 31 x 82 h.	1,8	3,8	515,00
					<p>Led integrato non sostituibile/ Led included not replaceable</p> <p>Led 14W-3000K</p>  <p> Dimmer touch</p>	

# Magoo

Massimo Belloni 1996

Applique con diffusore in vetro soffiato opalino bianco.

Wall lamp with shade in opal white blown glass.



Wandleuchte mit Schirm aus weißem geblasenem Opalglas.

Applique avec abat-jour en verre soufflé opalin blanc.

Lámparas de pared con difusor de vidrio soplado opal blanco.

9618

Applique Wall

codice code	cavo elettrico cm electric cable cm	IMBALLO CM/PACKAGING CM SH = Shade ST = Structure	peso netto kg. net weight kg.	peso lordo kg. gross weight kg.	lampadina bulb	€ iva esclusa € tax not included
9618-30		45 x 45 x 28 h.	2	3	<p> 2 x 5W LED - E27</p> <p>oppure/or</p> <p> 2 x max 60W - E27 Halo</p>	255,00

Lampadina esclusa / Bulb not included

# Mami Umberto Asnago 2013

Lampade con struttura in metallo nichel nero lucido o bronzo. Diffusore in vetro soffiato bianco, ambra e fumo trasparente.

Lamps with structure in glossy black nickel metal or bronze. Shade in blown glass in white, transparent amber or fumé.



Lampen mit Struktur aus glänzendem schwarzem Nickel oder Bronze. Schirm aus geblasenem Glas in Farben weiss, transparent bernstein oder fumé.

Lampes avec structure en métal nickel noir poli ou bronze. Abat-jour en verre soufflé blanc, ambre ou fumé transparente.





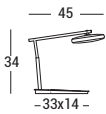
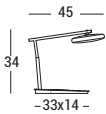





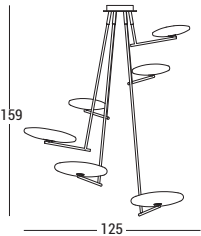

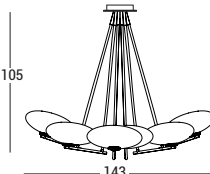

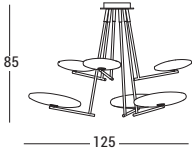
Lámparas con estructura en metal níquel negro brillante o bronzo. Difusor en cristal soplado blanco, ámbar o fumé transparente.

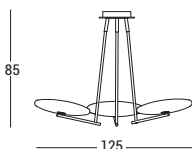

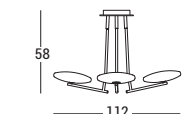

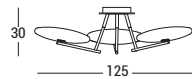







1307

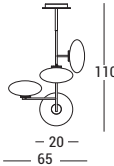

Tavolo Table

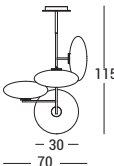
codice code		cavo elettrico cm electric cable cm	IMBALLO CM/PACKAGING CM SH = Shade ST = Structure	peso netto kg. net weight kg.	peso lordo kg. gross weight kg.	lampadina bulb	€ iva esclusa € tax not included
1307-03-02 LARGE		VETRO ø 30 GLASS ø 30					nichel nero/ black nickel
		160	SH 45 x 45 x 27 h.	2,3	2,7	Led integrato/Led included	860,00
1307-05-01 SMALL		VETRO ø 20 GLASS ø 20					nichel nero/ black nickel
		160	SH 31 x 31 x 32 h.	1,0	1,5	Led integrato/Led included	695,00
1307-01-01 SMALL		VETRO ø 20 GLASS ø 20					nichel nero/ black nickel
		160	SH 31 x 31 x 32 h.	1,0	1,5	Led integrato/Led included	645,00
1307-10-03		VETRO ø 40 GLASS ø 40					nichel nero/ black nickel
		180	BA 39 x 39 x 22 h.	12,0	13,5	Led integrato/Led included	1.340,00
			SH 55 x 55 x 35 h.	4	4,6	Led integrato/Led included	bronzo bronze
			ST 161 x 40 x 9 h.	2	3	Led 13W-3000K	1.395,00

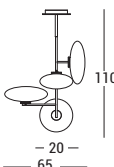
Terra Floor

codice code		cavo elettrico cm electric cable cm	IMBALLO CM/PACKAGING CM SH = Shade ST = Structure	peso netto kg. net weight kg.	peso lordo kg. gross weight kg.	lampadina bulb	€ iva esclusa € tax not included
<b>1307-24-23</b> MAXI		N° 3 VETRI Ø 30 N° 3 SHADES Ø 30 N° 3 VETRI Ø 40 N° 3 SHADES Ø 40	3xSH 45 x 45 x 27 h.	2,3	2,7		nickel nero/ black nickel <b>2.995,00</b>
			3xSH 55 x 55 x 35 h.	4	4,6	Led integrato/Led included 	bronzo bronze <b>3.195,00</b>
			ST 45 x 65 x 165 h.	12,5	14	Led 6x13W-3000K	
<b>1307-25-33</b> EXTRA LARGE		N° 6 VETRI Ø 40 N° 6 SHADES Ø 40	6xSH 55 x 55 x 35 h.	4	4,6	Led integrato/Led included 	nickel nero/ black nickel <b>3.650,00</b>
			ST 45 x 65 x 165 h.	12,5	14	Led 6x13W-3000K	bronzo bronze <b>3.850,00</b>
<b>1307-23-23</b> LARGE		N° 3 VETRI Ø 30 N° 3 SHADES Ø 30 N° 3 VETRI Ø 40 N° 3 SHADES Ø 40	3xSH 45 x 45 x 27 h.	2,3	2,7		nickel nero/ black nickel <b>2.795,00</b>
			3xSH 55 x 55 x 35 h.	4	4,6	Led integrato/Led included 	bronzo bronze <b>2.985,00</b>
			ST 45 x 65 x 90 h.	10,5	12	Led 6x13W-3000K	
<b>1307-22-03</b> MEDIUM		N° 3 VETRI Ø 40 N° 3 SHADES Ø 40	3xSH 55 x 55 x 35 h.	4	4,6	Led integrato/Led included 	nickel nero/ black nickel <b>1.745,00</b>
			ST 45 x 65 x 90 h.	7,5	9	Led 3x13W-3000K	bronzo bronze <b>1.865,00</b>
<b>1307-21-02</b> SMALL		N° 3 VETRI Ø 30 N° 3 SHADES Ø 30	3xSH 45 x 45 x 27 h.	2,3	2,7	Led integrato/Led included 	nickel nero/ black nickel <b>1.545,00</b>
			ST 61 x 40 x 18 h.	6,5	8	Led 3x13W-3000K	bronzo bronze <b>1.645,00</b>
<b>1307-41-03</b> LARGE		N° 3 VETRI Ø 40 N° 3 SHADES Ø 40	3xSH 55 x 55 x 35 h.	2,3	2,7	Led integrato/Led included 	nickel nero/ black nickel <b>1.385,00</b>
			ST 61 x 40 x 18 h.	5,5	7	Led 3x13W-3000K	bronzo bronze <b>1.495,00</b>
<b>1307-41-02</b> SMALL		N° 3 VETRI Ø 30 N° 3 SHADES Ø 30	3xSH 45 x 45 x 27 h.	2,3	2,7	Led integrato/Led included 	nickel nero/ black nickel <b>1.295,00</b>
			ST 61 x 40 x 18 h.	5,5	7	Led 3x13W-3000K	bronzo bronze <b>1.395,00</b>

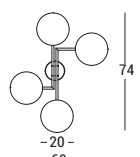
codice code	cavo elettrico cm electric cable cm	IMBALLO CM/PACKAGING CM SH = Shade ST = Structure	peso netto kg. net weight kg.	peso lordo kg. gross weight kg.	lampadina bulb	€ iva esclusa € tax not included
<b>1307-31-03</b> LARGE	 Disponibili solo in vetro bianco Available in white glass only	SH 55 x 55 x 35 h.	4,5	5,5	Led integrato/Led included 	nickel nero/ black nickel <b>370,00</b>
		ST 17 x 17 x 17 h.	1,5	2,0	Led 13W-3000K	bronzo bronze <b>395,00</b>
<b>1307-31-02</b> MEDIUM	 Disponibili solo in vetro bianco Available in white glass only	SH 45 x 45 x 27 h.	1,5	2,0	Led integrato/Led included 	nickel nero/ black nickel <b>345,00</b>
		ST 17 x 17 x 17 h.	2,3	2,7	Led 13W-3000K	bronzo bronze <b>365,00</b>
<b>1307-31-01</b> SMALL	 Disponibili solo in vetro bianco Available in white glass only	SH 32 x 32 x 32 h.	1	1,5	Led integrato/Led included 	nickel nero/ black nickel <b>295,00</b>
		ST 17 x 17 x 17 h.	1,5	2,5	Led 8W-3000K	bronzo bronze <b>310,00</b>
<b>1307-26-01</b>	 N° 4 VETRI Ø 20 N° 4 SHADES Ø 20	4xSH 32 x 32 x 32 h.	1	1,5	Led integrato/Led included 	nickel nero/ black nickel <b>1.860,00</b>
		ST 41 x 41 x 137 h.	8	10	Led 13W-3000K	bronzo bronze <b>1.950,00</b>
<b>1307-26-02</b>	 N° 4 VETRI Ø 30 N° 4 SHADES Ø 30	4xSH 45 x 45 x 27 h.	2,3	2,7	Led integrato/Led included 	nickel nero/ black nickel <b>1.985,00</b>
		ST 41 x 41 x 137 h.	8	10	Led 13W-3000K	bronzo bronze <b>2.100,00</b>
<b>1307-26-04</b>	 N° 2 VETRI Ø 20 N° 2 VETRI Ø 30 N° 4 SHADES Ø 20 N° 4 SHADES Ø 30	2xSH 32 x 32 x 32 h.	1	1,5	Led integrato/Led included 	nickel nero/ black nickel <b>1.925,00</b>
		2xSH 45 x 45 x 27 h. ST 41 x 41 x 137 h.	2,3 8	2,7 10	Led 13W-3000K	bronzo bronze <b>2.025,00</b>

codice code	cavo elettrico cm electric cable cm	IMBALLO CM/PACKAGING CM SH = Shade ST = Structure	peso netto kg. net weight kg.	peso lordo kg. gross weight kg.	lampadina bulb	€ iva esclusa € tax not included
1307-42-01		4xSH 32 x 32 x 32 h.	1	1,5	Led integrato/Led included	nickel nero/ black nickel <b>1.195,00</b>
		ST 30 x 45 x 65 h.	5	7	 Led 13W-3000K	bronzo bronze <b>1.295,00</b>

**SU PROGETTO A RICHIESTA / ON DEMAND**

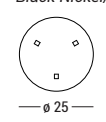
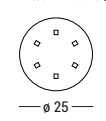
1307-R-03 3 FORI	Nichel Nero/Bronzo Black Nickel/Bronze 
1307-R-06 6 FORI	Nichel Nero/Bronzo Black Nickel/Bronze 

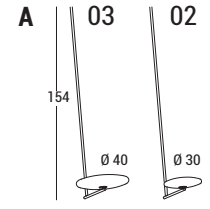
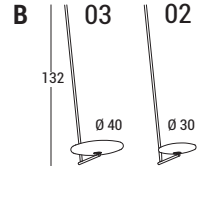
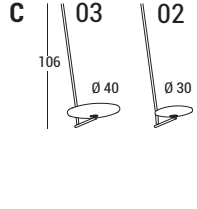
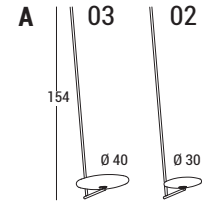
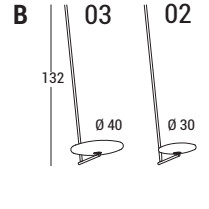
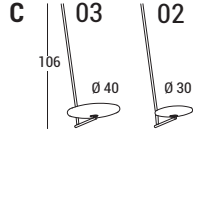
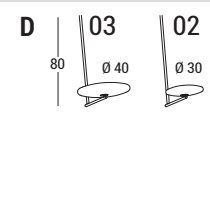
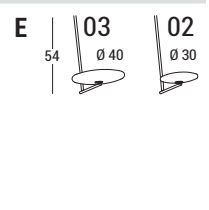
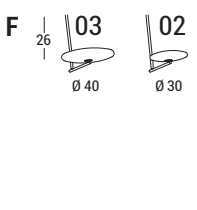
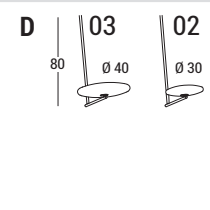
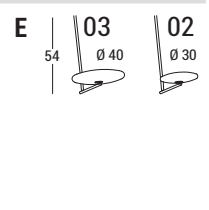
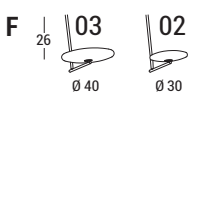
1307-A-03 Ø 40	<b>A</b> 03 02 	1307-B-03 Ø 40	<b>B</b> 03 02 	1307-C-03 Ø 40	<b>C</b> 03 02 
1307-A-02 Ø 30		1307-B-02 Ø 30		1307-C-02 Ø 30	
1307-D-03 Ø 40	<b>D</b> 03 02 	1307-E-03 Ø 40	<b>E</b> 03 02 	1307-F-03 Ø 40	<b>F</b> 03 02 
1307-D-02 Ø 30		1307-E-02 Ø 30		1307-F-02 Ø 30	

**PRODUZIONE SPECIALI / CUSTOM MADE**



**A RICHIESTA: PROGETTO, PREZZI E TEMPI DI CONSEGNA**  
**ON DEMAND: PROJECT, PRICES AND DELIVERY TIME**



# MoM Family Umberto Asnago 2016

Collezione di lampade a sospensione in cinque forme realizzate in vetro borosilicato :  
 - finitura metallica ossidata opaca nei colori senape, blu avio, verde salvia, rosa cipria, sabbia, bianco e nero  
 - trasparente  
 Rosone a soffitto bianco o nero.  
 A RICHIESTA: estensione cablaggio elettrico.  
**€ 9,00/mt + IVA**

Collection of pendant lamps in five shapes made in borosilicate glass:  
 - mat oxidized metallic finish in the colours mustard, blue avio, sage green, powder pink, sand, white and black  
 - transparent  
 Canopy in white or black varnished metal  
 ON DEMAND : longer electrical cable  
**€ 9,00/mt**









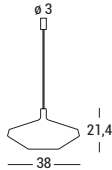

Hängeleuchte Kollektion in fünf Formen vorgeschlagen aus Borosilikatglas :  
 - matte metallische oxidierte Ausführung in den Farben senf, avio blau, salbei grün, puder rosa, sand, weiß und schwarz  
 - transparent  
 Deckbefestigung aus weißem oder schwarzem lackiertem Metall  
 AUF VERLANGEN: längere elektrische Kabel  
**€ 9,00/mt**

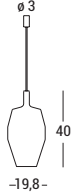
Collection de suspensions en cinq formes en verre borosilicate :  
 - finition métallique oxidé opaque dans les couleurs moutarde, bleu avio, vert sauge, rose poudre, sable, blanc et noir  
 - transparent  
 Rosace en metal verni blanc ou noir  
 SUR DEMANDE : cable électrique plus long  
**€ 9,00/mt**

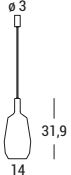
Colección de lámparas de suspensión en cinco formas realizadas en cristal borosilicado:  
 - Acabado metálico oxidado opaco en color mostaza, azul avio, verde salvia, rosa pálido, sabbia, blanco y negro  
 - Transparente Rosetón a techo blanco o negro  
 BAJO PEDIDO: extensión del cable eléctrico  
**€ 9,00/mt**

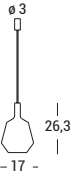
1602

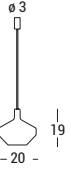
Sospensioni Pendant

codice code		cavo elettrico cm electric cable cm	IMBALLO CM/PACKAGING CM SH = Shade ST = Structure	peso netto kg. net weight kg.	peso lordo kg. gross weight kg.	lampadine bulb	€ iva esclusa € tax not included
<b>1602-21</b> LOW		200	55 x 55 x 32,5 h.	1,8	3,5	 1 x 10W LED - E27 oppure/or  1 x max 60W Halo E27	Trasparente/Transparent <b>705,00</b> Colorato/Coloured <b>870,00</b>
<b>1602-22</b> TALL		200	37 x 37 x 62 h.	1,8	3,5	 1 x 10W LED - E27 oppure/or  1 x max 60W Halo E27	Trasparente/Transparent <b>445,00</b> Colorato/Coloured <b>575,00</b>
<b>1602-23</b> SLIM		200	27 x 27 x 52 h.	1	2,3	 1 x 10W LED - E27 oppure/or  1 x max 60W Halo E27	Trasparente/Transparent <b>325,00</b> Colorato/Coloured <b>435,00</b>
<b>1602-24</b> FATTY		200	27 x 27 x 37 h.	0,8	2	 1 x 5W LED - E14 oppure/or  1 x max 42W Halo E14	Trasparente/Transparent <b>290,00</b> Colorato/Coloured <b>390,00</b>
<b>1602-25</b> LITTLE		200	31 x 31 x 32 h.	0,8	2	 1 x 5W LED - E14 oppure/or  1 x max 42W Halo E14	Trasparente/Transparent <b>275,00</b> Colorato/Coloured <b>365,00</b>

**Esempi di installazione/Installation examples**



Singola  
*Single*

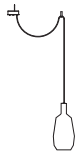

Singola con decentramento  
*Single decentralized*

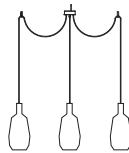

Multiple con decentramento  
*Multiple decentralized*

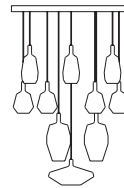

Composizione con piastra  
*Culster with plate*

**Piastre e rosoni pag. 73**  
***Plates and canopies pag. 73***

# New Classic

Umberto Asnago 2003/2008

Lampade con struttura in metallo nichel antracite opaco e vetro soffiato nei colori: trasparente, fumé, ambra, ametista, rubino, zaffiro, verde oliva. Paralumi intercambiabili in varie misure nei tessuti della collezione, **escluso plissé seta a mano**. Chiusura superiore totale in plexiglas per lampada da tavolo.

Lamps with structure in opaque anthracite nickel and blown glass in the following colours: transparent, fumé, amber, amethyst, ruby, sapphire, olive-green. Interchangeable shades in different sizes in the fabrics of the collection, **hand-made silk plissé excluded**. Complete top closure in plexiglas for table lamp only.

Lampen mit Struktur aus matt Antrazit Nickel matt Anthrazit und geblasenem Glas in den Farben: transparent, fumé, bernsteinfarbig, Amethyst, Rubinrot, Saphirblau, Olivgrün. Austauschbare Schirme in verschiedenen Formen in den Stoffen der Kollektion, **hand-gefertigte Seide plissé nicht einschliesslich**. Ganze Oberabdeckung aus Plexiglas für Tischleuchte.

Lampes avec structure en métal nickel opaque anthracite et verre soufflé dans les couleurs: transparent, fumé, ambre, amethyst, rubis, saphir, vert-olive. Abats-jour interchangeables en différentes formes dans les tissus de la collection, **plissé soie à main pas inclus**. Fermeture supérieure complète en plexiglas pour les lampes à poser.

Lámparas con estructura en níquel antracita opaco y vidrio soplado en los colores: transparente, fumé, ámbar, amatista, rubí, zafiro, olive. Pantallas intercambiables en varias medidas en los tejidos de la colección, **excepto plissé de seda hecho a mano**. Cierre superior total en plexiglas por lampara de mesa.

0204-5-6



Tavolo Table

codice code	cavo elettrico cm electric cable cm	IMBALLO CM/PACKAGING CM SH = Shade ST = Structure	peso netto kg. net weight kg.	peso lordo kg. gross weight kg.	lampadina bulb	€ iva esclusa € tax not included	
						vetro trasparente/ transparent glass	vetro colorato/ coloured glass
0204-00 BON TON	160	A = SH 55 x 55 x 35 h.	0,5	1,7	1 x 10W LED - E27 oppure/or 1 x max 100W - E27 Halo/Fluo	cat. A/B <b>500,00</b>	cat. A/B <b>520,00</b>
		B = SH 41 x 41 x 53 h.	0,5	1,7			
		C = SH 55 x 55 x 35 h.	0,5	1,7			
0205-00 DESIR	160	A = SH 55 x 55 x 35 h.	0,5	1,7	1 x 10W LED - E27 oppure/or 1 x max 100W - E27 Halo/Fluo	cat. A/B <b>460,00</b>	cat. A/B <b>480,00</b>
		B = SH 41 x 41 x 53 h.	0,5	1,7			
		C = SH 55 x 55 x 35 h.	0,5	1,7			
0206-00 PASCIA	160	A = SH 55 x 55 x 35 h.	0,5	1,7	1 x 10W LED - E27 oppure/or 1 x max 100W - E27 Halo/Fluo	cat. A/B <b>520,00</b>	cat. A/B <b>540,00</b>
		B = SH 41 x 41 x 53 h.	0,5	1,7			
		C = SH 55 x 55 x 35 h.	0,5	1,7			

## Lampadina esclusa / Bulb not included

Varianti paralumi:  
Available shades:

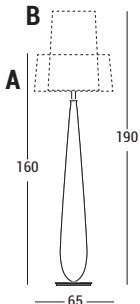

codice code	cavo elettrico cm electric cable cm	IMBALLO CM/PACKAGING CM SH = Shade ST = Structure	peso netto kg. net weight kg.	peso lordo kg. gross weight kg.	lampadina bulb	€ iva esclusa € tax not included	
						vetro trasparente/ transparent glass	vetro colorato/ coloured glass
<b>0204-10</b> BON TON		A = SH 70 x 70 x 35 h.	0,7	3	 1 max 100/150W E27 Halo  Dimmer	cat. A/B <b>985,00</b>	cat. A/B <b>1.170,00</b>
		B = SH 49 x 49 x 78 h.	0,5	3		cat. Extra <b>1.095,00</b>	cat. Extra <b>1.280,00</b>
		ST 40 x 40 x 148 h.	10,0	16			

**Lampadina esclusa / Bulb not included**

Varianti paralumi:  
Available shades:

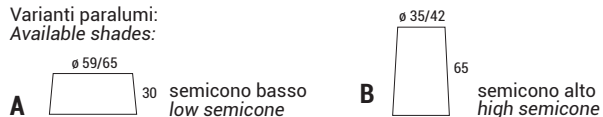

# Panona Umberto Asnago 1995

Lampade con struttura in metallo nichel satinato. Diffusore in vetro soffiato opalino bianco.

Lamps with structure in nickel satin metal. Shade in opal white blown glass.





Lampen mit Struktur aus Metall Nickel satiniert. Schirm aus opalweißem geblasenem Glas.

Lampes avec structure en métal nickel satiné. Abat-jour en verre soufflé opalin blanc.

Lámparas con estructura en metal níquel satinado. Difusor de vidrio soplado opal blanco.

9524

Terra Floor

codice code	cavo elettrico cm electric cable cm	IMBALLO CM/PACKAGING CM SH = Shade ST = Structure	peso netto kg. net weight kg.	peso lordo kg. gross weight kg.	lampadina bulb	€ iva esclusa € tax not included
9524-10	200	SH 33 x 33 x 124 h.	5	7	 1 x 10W LED R7s 78 mm  <b>Lampadina inclusa/ Bulb included</b>	995,00
		ST 36 x 36 x 184 h.	10	12	 sup. 1 x max 250W R7s 78 mm Halo  <b>Lampadina esclusa/ Bulb not included</b>  inf. 6 x max 42W E14 oliva Halo   Dimmer	



Applique/Plafoniera Wall/Ceiling

9524-40		SH 33 x 33 x 124 h.	2,5	4	<b>Lampadina inclusa/ Bulb included</b>  2 x max 30W G13 Fluo	490,00
		ST 18 x 18 x 130 h.	1,5	2,5		

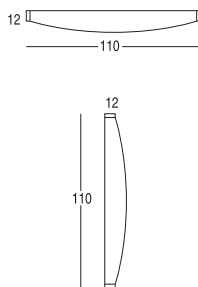

 = lampadina compresa solo per 230 V~(NO 110V~)  
bulb included only for 230V~ (NOT 110V~)

# Planet

Wanni Rondani 1998

Sospensione con struttura in metallo nickel satinato e diffusore in vetro soffiato trasparente

Pendant with structure in nickel satin metal. Shade in transparent blown glass.



Hängeleuchte mit Struktur aus Metall Nickel satiniert. Schirm aus transparentem geblasenem Glas.

Suspension avec structure en métal nickel satiné. Abat-jour en verre soufflé transparent.

Lámpara de techo con estructura en metal níquel satinado. Difusor en vidrio soplado transparente.

9826

Sospensione Pendant

codice code	cavo elettrico cm electric cable cm	IMBALLO CM/PACKAGING CM SH = Shade ST = Structure	peso netto kg. net weight kg.	peso lordo kg. gross weight kg.	lampadina bulb	€ iva esclusa € tax not included
9826-20	200	37 x 37 x 48 h.	2,8	3,5	 1 x 10W LED - E27 oppure/or  1 x max 100W - E27 Halo/Fluo	345,00



Lampadina esclusa / Bulb not included

# Polar Umberto Asnago 2011

Lampade da terra e tavolo con struttura in nickel satinato o bronzo. Diffusore in vetro soffiato opalino bianco.

Floor and table lamps with structure in satin nickel metal or bronze. Shade in white opal blown glass.





Steh- und Tischleuchten mit Struktur aus satiniertem Nickel Metall oder Bronze. Schirm aus opalweissem geblasenem Glas.

Lampadaires et lampes à poser avec structure en metal nickel satiné ou bronze. Abat-jour en verre soufflé blanc opaline.

Lámparas de pie y sobremesa con estructura en bronce y níquel satinado. Difusor de cristal soplado blanco.

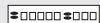

1106

Tavolo Table

codice code	cavo elettrico cm electric cable cm	IMBALLO CM/PACKAGING CM SH = Shade ST = Structure	peso netto kg. net weight kg.	peso lordo kg. gross weight kg.	lampadina bulb	€ iva esclusa € tax not included
<b>1106-03</b> LARGE	180	SH 45 x 45 x 30 h.	2,0	3,5	Led integrato non sostituibile/ Led included not replaceable  LED 28,8W-2700K  Dimmer	Nickel <b>780,00</b>
		ST 69 x 52 x 34 h.	6,5	7,5		Bronzo/Bronze <b>795,00</b>
<b>1106-01</b> SMALL	180	45 x 45 x 30 h.	3,5	4,8	 1 x max 70W E27 Halo  Dimmer	Nickel <b>340,00</b>
						Bronzo/Bronze <b>350,00</b>

## Lampadina esclusa / Bulb not included

Terra Floor

<b>1106-10</b>	180	SH 45 x 45 x 147 h.	21,5	25	Led integrato non sostituibile/ Led included not replaceable  LED 58W-2700K  Dimmer	Nickel <b>1.550,00</b>
		SH 21 x 31 x 162 h.				Bronzo/Bronze <b>1.595,00</b>

# Stilo

Piva Associati 2009

Applique e plafoniera in espanso termoplastico bianco.  
Orientabile 180° e basculante.

Wall and ceiling lamp in glossy white thermoplastic expansion.  
180° adjustable and tilting.



Wand- und Deckenleuchte aus glänzender weißen thermoplastischer.  
180° verstellbar und vor und zurück beweglich.

Applique et plafonier en expansion thermoplastique blanc poli.  
Orientable 180° et basculant.

Applique y plafones en expansión termoplástica blanco brillantes.  
Orientable 180° y basculante.

0804

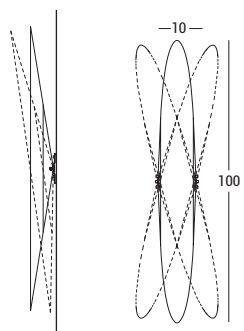
Applique/Plafoniera Wall/Ceiling

codice code	cavo elettrico cm electric cable cm	IMBALLO CM/PACKAGING CM SH = Shade ST = Structure	peso netto kg. net weight kg.	peso lordo kg. gross weight kg.	lampadina bulb	€ iva esclusa € tax not included
0804-40		33 x 33 x 124 h.	1,2	3,3	 2 x max 11W 2G7 Fluor	330,00

Lampadina esclusa / Bulb not included

# Taaac

Umberto Asnago 2009

Lampada da terra con base in metallo nero gofrato e struttura in espanso termoplastico lucido o rivestita in cuoio.

Finitura:

- espanso termoplastico lucido: bianco, nero
- **cuoio** tinta unita o bicolore: bianco, nero, testa di moro, beige, tortora, avorio.

**Orientabile 360°.**

**Luce LED superiore ed inferiore con accensione separata con telecomando.**

Floor lamp with base in embossed black metal and structure in glossy thermoplastic expansion or covered with leather.

Finishing:

- glossy thermoplastic expansion: white, black
- **leather** one colour or two colours: white, black, testa di moro, beige, tortora, ivory.

**360° adjustable.**

**Upper and lower separated LED lighting with remote control.**

Stehleuchte mit Sockel aus schwarzem gaufriertem Metal und Struktur aus glänzender thermoplastischer Expansion oder mit Leder bezogen.

Ausführung:

- glänzende thermoplastische Expansion: Weiß, Schwarz, Leder
- **Leder** Einfarbig oder Zweifarbig: Weiß, Schwarz, Testa di moro, Beige, Tortora, Elfenbein.

**360° drehbare.**

**Ober- und Unterlicht LED mit getrennter Zündung mit Fernsteuerung.**

Lampadaire avec base en métal noir gaufré et structure en expansion thermoplastique polie ou recouverte en cuir.

Finition:

- Expansion thermoplastique polie: blanc, noir
- **Cuir** teinte unie ou bicolore: blanc, noir, testa di moro, beige, tortora, ivoire.

**Orientable 360°.**

**LED supérieur et inférieur avec allumage séparée par télécommande.**

Lámparas de pie con base en metal negro gofrado y estructura en expansión termoplástica brillante o revestida en cuero.

Acabado:



- expansión termoplástica brillante: blanco, negro
- **cuero** un solo color o dos colores: blanco, negro testa di moro, beige, tortora, marfil.

**Orientable 360°.**

**LED superior y inferior con telecomando.**

0808

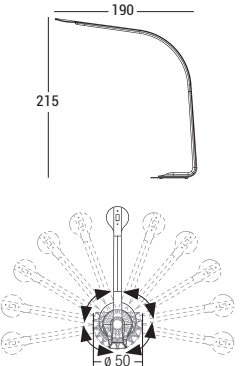
Terra Floor

codice code	cavo elettrico cm electric cable cm	IMBALLO CM/PACKAGING CM SH = Shade ST = Structure	peso netto kg. net weight kg.	peso lordo kg. gross weight kg.	lampadina bulb	€ iva esclusa € tax not included
0808-10		SUP. 226x35x100 h. INF. 66x58x130 h.	SUP. 8 INF. 28	SUP. 20 INF. 38	<p>LED integrato non sostituibile/ Led included not replaceable</p> <p> SUP. LED 3W-3500K</p> <p> INF. LED 25W-2900/5000K</p>	<p>laccata-lacquered <b>2.470,00</b></p> <p>cuoio-leather <b>3.265,00</b></p>



# Tic&Toc Umberto Asnago 2013

Lampade con struttura in metallo nichel antracite opaco e vetro soffiato nei colori: trasparente, ametista, fumé, rubino, zaffiro, oliva, ámbar. Paralumi intercambiabili nelle forme e nei tessuti della collezione. **Escluso plissé seta a mano.** Disponibile diffusore semicono alto in vetro nei colori previsti per le basi.

Lamps with structure in opaque anthracite nickel and blown glass in the following colours: transparent, amethyst, fumé, ruby, sapphire, olive-green, amber. Interchangeable shades in different sizes in the fabrics of the collection. **Hand-made silk plissé excluded.** High semicone shade available in glass in the same colours of the base.

Lampen mit Struktur aus matt anthrazit Nickel und geblasenem Glas in den Farben: transparent, Amethyst, Fumé, Rubinrot, Saphirblau, Olivgrün, bernsteinfarbig. Austauschbare Schirmen in verschiedenen Formen in den Stoffen der Kollektion. **Handgefertigte Seide plissé nicht einschliesslich.** Hoch halbkegel Schirm auch aus Glas in den selben Farben von den Fuß lieferbar.

Lampes avec structure en métal nickel opaque anthracite et verre soufflé dans les couleurs: transparent, amethyst, fumé, rubis, saphir, vert-olive, ambre. Abats-jour interchangeables en formes différentes dans les tissus de la collection. **Plissé soie à main pas inclus.** L'abat-jour semicone haute peut être aussi disponible en verre dans les même couleurs du pied.

Lámparas con estructura en metal níquel antracita opaco y cristal soplado en los colores: transparente, amatista, humo, rubí, zafiro, olive, ámbar. Pantallas intercambiables en las formas y nuevos tejidos de la colección. **Excepto plissé de seda hecho a mano.** Disponible difusor en vidrio en los colores previstos para las bases.

1303 - 1304

Tavolo Table

codice code	cavo elettrico cm electric cable cm	IMBALLO CM/PACKAGING CM SH = Shade ST = Structure	peso netto kg. net weight kg.	peso lordo kg. gross weight kg.	lampadina bulb	€ iva esclusa € tax not included								
1303-00 TIC		SH 40 x 40 x 60 h.	3,5	5	1 x 10W LED - E27 oppure/or 1 x max 100W - E27 Halo/Fluo	<table border="1"> <thead> <tr> <th>struttura trasparente/ transparent structure</th> <th>struttura colorata/ coloured structure</th> </tr> </thead> <tbody> <tr> <td>Diffusore vetro blown glass shade <b>895,00</b></td> <td>Diffusore vetro blown glass shade <b>1.195,00</b></td> </tr> <tr> <td>Tessuto/ Fabrics Cat. A e B <b>760,00</b></td> <td>Tessuto/ Fabrics Cat. A e B <b>795,00</b></td> </tr> <tr> <td>Tessuto/ Fabrics cat. Extra <b>825,00</b></td> <td>Tessuto/ Fabrics cat. Extra <b>845,00</b></td> </tr> </tbody> </table>	struttura trasparente/ transparent structure	struttura colorata/ coloured structure	Diffusore vetro blown glass shade <b>895,00</b>	Diffusore vetro blown glass shade <b>1.195,00</b>	Tessuto/ Fabrics Cat. A e B <b>760,00</b>	Tessuto/ Fabrics Cat. A e B <b>795,00</b>	Tessuto/ Fabrics cat. Extra <b>825,00</b>	Tessuto/ Fabrics cat. Extra <b>845,00</b>
		struttura trasparente/ transparent structure	struttura colorata/ coloured structure											
Diffusore vetro blown glass shade <b>895,00</b>	Diffusore vetro blown glass shade <b>1.195,00</b>													
Tessuto/ Fabrics Cat. A e B <b>760,00</b>	Tessuto/ Fabrics Cat. A e B <b>795,00</b>													
Tessuto/ Fabrics cat. Extra <b>825,00</b>	Tessuto/ Fabrics cat. Extra <b>845,00</b>													
ST 31 x 31 x 102 h.	7	8,6												
1304-00 TOC		SH 70 x 70 x 35 h.	2	4,5	1 x 10W LED - E27 oppure/or 1 x max 100W - E27 Halo/Fluo	<table border="1"> <thead> <tr> <th>struttura trasparente/ transparent structure</th> <th>struttura colorata/ coloured structure</th> </tr> </thead> <tbody> <tr> <td>Diffusore vetro blown glass shade <b>950,00</b></td> <td>Diffusore vetro blown glass shade <b>1.285,00</b></td> </tr> <tr> <td>Tessuto/ Fabrics Cat. A e B <b>850,00</b></td> <td>Tessuto/ Fabrics Cat. A e B <b>885,00</b></td> </tr> <tr> <td>Tessuto/ Fabrics cat. Extra <b>915,00</b></td> <td>Tessuto/ Fabrics cat. Extra <b>935,00</b></td> </tr> </tbody> </table>	struttura trasparente/ transparent structure	struttura colorata/ coloured structure	Diffusore vetro blown glass shade <b>950,00</b>	Diffusore vetro blown glass shade <b>1.285,00</b>	Tessuto/ Fabrics Cat. A e B <b>850,00</b>	Tessuto/ Fabrics Cat. A e B <b>885,00</b>	Tessuto/ Fabrics cat. Extra <b>915,00</b>	Tessuto/ Fabrics cat. Extra <b>935,00</b>
		struttura trasparente/ transparent structure	struttura colorata/ coloured structure											
Diffusore vetro blown glass shade <b>950,00</b>	Diffusore vetro blown glass shade <b>1.285,00</b>													
Tessuto/ Fabrics Cat. A e B <b>850,00</b>	Tessuto/ Fabrics Cat. A e B <b>885,00</b>													
Tessuto/ Fabrics cat. Extra <b>915,00</b>	Tessuto/ Fabrics cat. Extra <b>935,00</b>													
SH 40 x 40 x 60 h.	3,5	5												
ST 49 x 49 x 78 h.	8	10												

## Lampadina esclusa / Bulb not included

Varianti paralumi:  
Available shades:

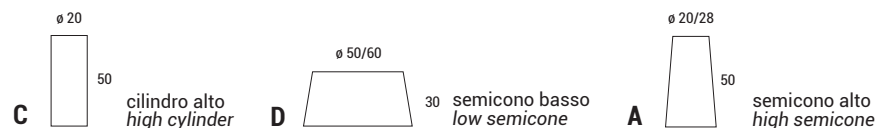

# Tocco

M+K design 2005

Lampade realizzate interamente in legno tinto wengé o rovere sbiancato. Pyrex interno.

Lamps in wood stained wengé or bleached oak. Inside pyrex.









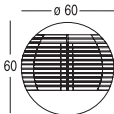

Lampen aus Wengéfarbig- oder Bleicheichfarbigholz. Innenpyrex.

Lampes en bois teinté wengé ou chêne blanchi. Pyrex à l'intérieur.

Lámparas realizadas completamente en madera tintada wengé o roble blanqueado. Pyrex interior.

0405

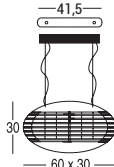
Tavolo Table

codice code		cavo elettrico cm electric cable cm	IMBALLO CM/PACKAGING CM SH = Shade ST = Structure	peso netto kg. net weight kg.	peso lordo kg. gross weight kg.	lampadina bulb	€ iva esclusa € tax not included
<b>0405-04-00</b> MAXI ROUND		200	72 x 72 x 70 h. + pyrex 30 x 30 x 30 h.	25	34	 1 x max 250W E27 Halo  Dimmer	legno wood <b>1.880,00</b>
<b>0405-03-00</b> LARGE ROUND		200	68 x 68 x 51 h.	10	13,8	 1 x max 150W E27 Halo  Dimmer	legno wood <b>1.090,00</b>
<b>0405-02-00</b> MEDIUM ROUND		160	55 x 42 x 37 h.	2	3,5	 1 x max 60W E14 Halo	legno wood <b>570,00</b>
<b>0405-23-20</b> OVAL		200	68 x 68 x 48 h.	6,5	9,5	 2 x max 60W E27 sfera Halo	legno wood <b>1.680,00</b>

Lampadina esclusa / Bulb not included

Sospensioni Pendant

# Tosca Umberto Asnago 2006

Lampade con struttura in metallo nickel antracite opaco o bronzo. Diffusore in vetro bianco opale o nei tessuti della collezione con chiusura superiore in plexiglas.

Lamps with structure in opaque anthracite nickel or bronze. Shade in opal white glass or in the fabrics of the collection with top closure in plexiglas.



Lampen mit Struktur aus matt anthrazit Nickel oder bronze. Schirm aus weißem Opalglas oder in den verschiedenen Stoffen der Kollektion mit oberer Abdeckung aus Plexiglas.

Lampes avec structure en métal nickel opaque anthracite ou bronze. Abat-jour en verre opale blanc ou dans le tissu de la collection avec fermeture supérieure en plexiglas.

Lámparas con estructura en níquel antracita opaco o bronzo. Difusor en vidrio opal blanco o en los tejidos de la colección con cierre superior en plexiglas.

0601

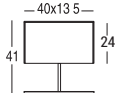
Tavolo Table

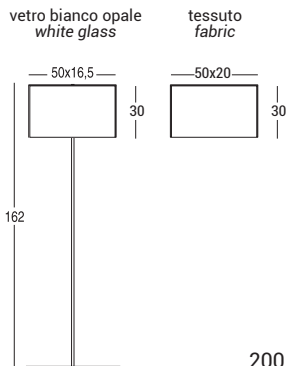
codice code	cavo elettrico cm electric cable cm	IMBALLO CM/PACKAGING CM SH = Shade ST = Structure	peso netto kg. net weight kg.	peso lordo kg. gross weight kg.	lampadina bulb	€ iva esclusa € tax not included	
Non realizzabile in PVC e pergamena Not available in PVC and parchment							
<b>0601-03</b> LARGE	tessuto/vetro bianco opale fabric/white glass 	SH 26 x 36 x 50 h.	tessuto-fabric	0,5	1,5	struttura nickel antracite/anthracite nickel structure Cat. A/B <b>395,00</b> cat. Extra plissé seta a mano hand made silk plissé 2 x 5W LED - E14 oppure/or 2 x max 60W - E14 Halo/Fluo	struttura bronzo/bronze structure Cat. A/B <b>525,00</b> cat. Extra plissé seta a mano hand made silk plissé 2 x max 60W - E14 Halo/Fluo
			vetro-glass	5,5	6,5		
	180	ST 55 x 55 x 35 h.	5	5,4		vetro bianco white glass <b>650,00</b> vetro bianco white glass <b>780,00</b>	
Non realizzabile in PVC e pergamena Not available in PVC and parchment							
<b>0601-01</b> SMALL	tessuto/vetro bianco opale fabric/white glass 	SH 20 x 30 x 40 h.	tessuto-fabric	0,3	1,3	struttura nickel antracite/anthracite nickel structure Cat. A/B <b>330,00</b> cat. Extra plissé seta a mano hand made silk plissé 2 x 5W LED - E14 oppure/or 2 x max 60W - E14 Halo/Fluo	struttura bronzo/bronze structure Cat. A/B <b>420,00</b> cat. Extra plissé seta a mano hand made silk plissé 2 x max 60W - E14 Halo/Fluo
			vetro-glass	2,5	3,5		
	180	ST 45 x 45 x 27 h.	2,8	3,2		vetro bianco white glass <b>465,00</b> vetro bianco white glass <b>555,00</b>	
Non realizzabile in PVC e pergamena Not available in PVC and parchment							
<b>0601-10</b>	vetro bianco opale white glass tessuto fabric 	SH 30 x 45 x 65 h.	tessuto-fabric	0,8	3,3	struttura nickel antracite/anthracite nickel structure Cat. A/B <b>680,00</b> cat. Extra plissé seta a mano hand made silk plissé 2 x max 100W E27 Halo Dimmer	struttura bronzo/bronze structure Cat. A/B <b>880,00</b> cat. Extra plissé seta a mano hand made silk plissé 2 x max 100W E27 Halo Dimmer
			vetro-glass	7,5	10		
	200	ST 30 x 60 x 176 h.	10	11		vetro bianco white glass <b>995,00</b> vetro bianco white glass <b>1.195,00</b>	

Lampadina esclusa / Bulb not included

# Vertigo

Umberto Asnago 2007

Sospensioni con struttura in metallo cromo nero lucido o bronzo con diffusori in vetro borosilicato fumé o trasparente.

**A RICHIESTA:**

- Versione dimmerabile
- Asta su misura.

Pendant lamps with structure in glossy black chromed metal or bronze with shades in fumé or transparent borosilicate glass.

**ON DEMAND:**

- Dimmerable version
- custom-size stem.

ängeleuchten aus glänzendem schwarz verchromtem Metall oder Bronze mit Schirmen aus fumé oder transparentem Borosilikatglas.

**AUF VERLÄNGERN:**

- Ausführung für Dimmer
- Stange mit Sondermaß.

Suspensions avec structure en metal chromé noir poli ou bronze avec abat-jour en verre borosilicate transparent ou fumé.

**SUR DEMANDE:**

- Version pour dimmer
- Tige sur mesure.







Lámparas de techo con estructura en metal cromado negro o bronce con difusores en vidrio borosilicado fumé o transparente.

**A PEDIDO:**

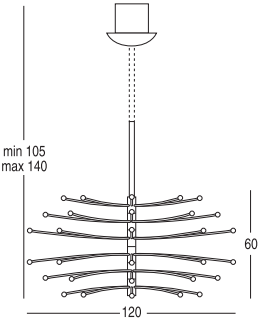
- Variante para dimmer
- Asta a medida

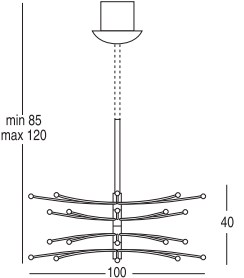
0707

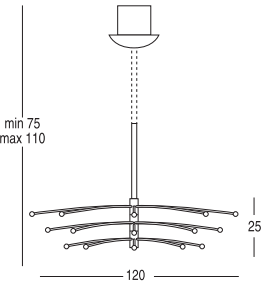
Sospensioni Pendant

codice code	cavo elettrico cm electric cable cm	IMBALLO CM/PACKAGING CM SH = Shade ST = Structure	peso netto kg. net weight kg.	peso lordo kg. gross weight kg.	lampadina bulb	€ iva esclusa € tax not included	
<b>0707-24</b> 48 LUCI/LIGHTS  			81 x 37 x 40 h.	24	26	 G4 48x2W 12V LED  € 3.395,00 netto	cromo nero black chrome <b>5.395,00</b>
						 1 x max 7W LED 12V Gu10  € 6.995,00 netto	bronzo bronze <b>6.995,00</b>
<b>0707-22</b> 32 LUCI/LIGHTS  			81 x 37 x 40 h.	20	22	 G4 32x2W 12V LED  € 3.885,00 netto	cromo nero black chrome <b>3.885,00</b>
						 1 x max 7W LED 12V Gu10  € 4.995,00 netto	bronzo bronze <b>4.995,00</b>
<b>0707-21</b> 24 LUCI/LIGHTS  			81 x 37 x 40 h.	18	20	 G4 24x2W 12V LED  € 3.195,00 netto	cromo nero black chrome <b>3.195,00</b>
						 1 x max 7W LED 12V Gu10  € 3.995,00 netto	bronzo bronze <b>3.995,00</b>

# Wonder

Bartoli Design 2015

Lampada a sospensione con struttura in metallo nei colori: oro opaco, rame opaco o grafite opaco. Diffusore in vetro borosilicato trasparente o fumé, disponibile in tre dimensioni: large, medium e mini. Rosone singolo nelle stesse finiture della struttura. Utilizzabile come elemento singolo o multiplo.

Pendant with metal structure in the colours: mat gold, mat copper or mat graphite. Shade in transparent or fume borosilicate glass, supplied in three sizes: large, small and mini. Single canopy in the same finishes of the structure. Available as single element or in cluster.







Hängeleuchte mit Struktur aus Metall in den Farben: mattGold, mattKupfer, mattGraphite. Schirm aus transparentem oder fumé Borosilikatglas, als groesse, kleine und mini Lampen lieferbar. Einzelne Deckbefestigung in den selben Farben der Struktur. Aus einzelne Element oder als Zusammenstellung erhältlich.

Suspension avec structure en métal dans les couleurs: dorée mat, cuivre mat, graphite mat. Abat-jour en verre borosilicate transparent ou fumé, disponible dans 3 tailles: grande, petite ou mini. Rosace individuelle dans les memes couleurs de la structure. On peut les utiliser individuellement ou en composition.

Lámpara de suspensión con estructura metálica en los colores: oro opaco, cobre opaco, grafito opaco. Difusor en vidrio borosilicado transparente o fumé, disponible en tres dimensiones: grande, media y mini. Roseton individual en el mismo acabado de la estructura. Utilizable como elemento individual o múltiple. Rosetón a techo blanco.

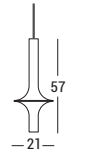
1504

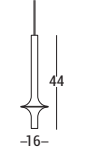
Sospensioni Pendant

codice code		cavo elettrico cm electric cable cm	IMBALLO CM/PACKAGING CM SH = Shade ST = Structure	peso netto kg. net weight kg.	peso lordo kg. gross weight kg.	lampadine bulb	€ iva esclusa € tax not included
1504-23 LARGE		200	40 x 40 x 75 h.	1,2	3,2	Led integrato non sostituibile/ Led included not replaceable	trasparente transparent
						 1 x 6W LED	colorato coloured
1504-21 MEDIUM		200	31 x 31 x 82 h.	0,9	2,8	Led integrato non sostituibile/ Led included not replaceable	trasparente transparent
						 1 x 6W LED	colorato coloured
1504-20 MINI		200	23 x 23 x 70 h.	0,8	2,5	Led integrato non sostituibile/ Led included not replaceable	trasparente transparent
						 1 x 6W LED	colorato coloured
1504- ROSONE							50,00

## Esempi di installazione/Installation examples



Singola  
Single



Composizione con piastra  
Cluster with plate

Piastre e rosoni pag. 78  
Plates and canopies pag. 78

# Wood

Nicola Gallizia 2000

Lampade rotonde o quadrate in legno tinto wengé, rovere sbiancato o miele. Diffusore disponibile nelle seguenti versioni:

- interamente in legno in tinta alla base;
- telaio in legno e tessuti: shantung, lino grezzo, linone e raso di seta;

**A richiesta per quantitativi (min 10 pz):**

- telaio in metallo e tessuti della collezione.
- chiusura superiore in plexiglas

Round or square lamps in wood stained wengé, bleached oak or honey colour. Shade available in the following versions:

- completely in wood in the same staining of the base;
- wooden frame with the fabrics: shantung, unbleached linen, linen and silk satin;

**On demand for quantity (min 10 pcs):**

- metal frame with the fabrics of the collection.
- top closure in plexiglas

Rund- oder Eckigelamp aus Wengé- Bleicheichfarbig oder Honigfarbigholz.

Schirm in den folgenden Modellen erhältlich:

- komplett aus Holz in derselben Farbe der Sockel;
- Holzgestell mit den Stoffen: Shantung, grezzo Leinen, Leinen und seide Satin;

**Auf Anfrage für Menge (min 10 stk):**

- Metallgestell mit den Stoffen der Kollektion.
- Oberer Abdeckung aus plexiglas

Lampes rondes ou carrées en bois teinté wengé, chêne blanchi ou couleur miel.

Abat-jour disponibles dans les versions suivantes :

- complètement en bois dans la même teinte de la base;
- cadre en bois avec les tissus: shantung, lin grezzo, lin et soie satin;

**Sur demande pour quantité (min 10 pcs):**

- cadre en métal avec les tissus de la collection.
- avec fermeture supérieure en plexiglas

Lámparas redondas o cuadradas en madera tintada wengé, roble o color miel.

Difusor disponible en las siguientes versiones:

- completamente en madera con el mismo color de la base;
- marco en madera y en los tejidos: shantung, lino grezzo, lino y raso de seda;

**Bajo pedido para cantidades (min 10 pcs):**

- marco en metal y en los tejidos de la colección.
- cierre superior en plexiglas

0132

Tavolo Table

codice code	cavo elettrico cm electric cable cm	IMBALLO CM/PACKAGING CM SH = Shade ST = Structure	peso netto kg. net weight kg.	peso lordo kg. gross weight kg.	lampadina bulb	€ iva esclusa € tax not included
0132-03 LARGE		SH 55 x 55 x 35 h.	1,5	3,5	1 x 10W LED - E27 oppure/or 1 x max 100W - E27 Halo	legno wood <b>695,00</b>
		ST 37 x 37 x 48 h.	1	1,8		legno+tessuto wood+fabric <b>650,00</b>
0132-01 SMALL		SH 31 x 31 x 62 h.	1,5	2,3	1 x 5W LED - E14 oppure/or 1 x max 60W - E14 Halo	legno wood <b>510,00</b>
		ST 40 x 40 x 170 h.	3	5		legno+tessuto wood+fabric <b>450,00</b>
0132-10		SH 55 x 55 x 35 h.	1,5	3,5	Max 1x150W E27 Halo	legno wood <b>860,00</b>
		ST 40 x 40 x 170 h.	3	5		legno+tessuto wood+fabric <b>810,00</b>
0132-20		SH 55 x 55 x 35 h.	1,7	3,7	1 x 10W LED - E27 oppure/or 1 x max 100W - E27 Halo/Fluo	legno wood <b>575,00</b>
		ST 40 x 40 x 170 h.	3	5		legno+tessuto wood+fabric <b>525,00</b>

Terra Floor

Sospensioni Pendant

# Woody

Umberto Asnago

Lampade a sospensione realizzate in: legno massello, noce, canaletto o in marmo bianco Carrara.

Pendants lamp in solid walnut wood or in Carrara white marble





Haengeleuchten aus Nussbaumholz oder in weissem Carrara Marmor

Suspensions en bois noix ou en marbre de Carrara blanc

Lámparas de suspensión realizadas en: madera de nogal, canaletto o en mármol blanco Carrara.

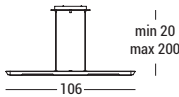
1406

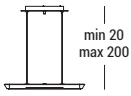
Sospensioni Pendant

codice code	cavo elettrico cm electric cable cm	IMBALLO CM/PACKAGING CM SH = Shade ST = Structure	peso netto kg. net weight kg.	peso lordo kg. gross weight kg.	lampadina bulb	€ iva esclusa € tax not included
1406-23 LARGE		200	135 x 25 x 25 h.	4	6	legno wood <b>995,00</b>
						Led integrato non sostituibile/ Led included not replaceable  12W - 24V LED 3000K marmo marble <b>1.395,00</b>
1406-21 SMALL		200	85 x 25 x 25 h.	3	5	legno wood <b>695,00</b>
						Led integrato non sostituibile/ Led included not replaceable  24,5W - 24V LED 3000K marmo marble <b>895,00</b>

# 4000

Applique orientabile in cromo lucido o ottone satinato.

Adjustable wall lamp in glossy chrome or satin brass.



Verstellbare Wandleuchte aus glänzendem Chrom oder satiniertem Messing.

Applique orientable en chrome poli ou laiton satiné.

Applique orientable con acabados en cromo brillo o latón satinado.

9236

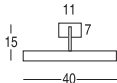
Applique Wall

codice code	cavo elettrico cm electric cable cm	IMBALLO CM/PACKAGING CM SH = Shade ST = Structure	peso netto kg. net weight kg.	peso lordo kg. gross weight kg.	lampadina bulb	€ iva esclusa € tax not included
9236-30		45 x 45 x 28 h.	0,8	1,5	 2 x max 40W E14 Halo	<b>285,00</b>

Lampadina esclusa / Bulb not included





# Sospensioni tessuto / Fabric pendants

Sospensioni con struttura in metallo rivestita con i tessuti della collezione. **Escluso PVC specchiato e plissé seta a mano.**

Cablaggio elettrico con rosace nichel satinato, cavo acciaio e filo trasparente.

**A RICHIESTA:**

- estensione cablaggio elettrico € 12,00/mt + IVA
- chiusura superiore per ø da 60 a 100

Pendants with metal structure covered with the fabrics of the collection. **Hand-made silk plissé and mirroring PVC excluded.**

Electrical wiring with nickel satin canopy, steel hanging cable and transparent electrical cable.

**ON DEMAND:**

- longer electrical and hanging cables € 12,00/mt
- upper closure from ø 60 to 100

Hängeleuchte mit Struktur aus Metall mit den Stoffen der Kollektion bezogen.

**Handgefertigte Seide plissé und Spiegel - PVC nicht einschliesslich.** Elektrische Verkabelung mit Deckbefestigung Nickel satiniert, Hängkabel aus Stahl und Transparentelektroschickabel.

**AUF VERLANGEN:**

- längere elektrische und Hängkabel € 12,00/mt
- Obenerabdeckung von ø 60 zu 100

Suspensions avec structure en métal revêtue avec les tissus de la collection.

**Plissé soie à main et PVC réfléchissant pas inclus.** Câblage électrique avec rosace calotte en nickel satiné, câble de support en acier et câble électrique transparent.

**SUR DEMANDE:**







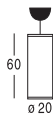

- câbles électriques et de suspension plus longs € 12,00/mt
- Fermeture supérieure du ø 60 à 100

Lámparas de techo con estructura en metal recubierto en los tejidos de la colección. **Excepto plissé de seda hecho a mano y PVC espejado.** Cableado eléctrico con roseton níquel satinado, cable de fijación en acero y cable eléctrico transparente.



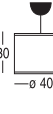

**A PEDIDO:**









- cables eléctricos y colgantes más largos € 12,00/mt
- Cierre superior de ø 60 a 100

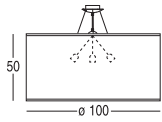

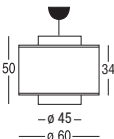

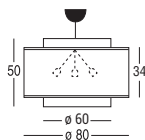

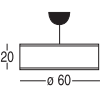

Sospensioni Pendant

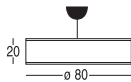

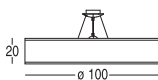

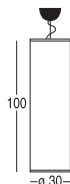

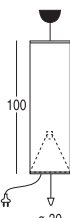





codice code	cavo elettrico cm electric cable cm	IMBALLO CM/PACKAGING CM SH = Shade ST = Structure	peso netto kg. net weight kg.	peso lordo kg. gross weight kg.	lampadina bulb	€ iva esclusa € tax not included
 <b>9229-20-54</b> CYLINDER	200	31 x 31 x 82 h.	0,9	2,3	 1 x 10W LED - E27 oppure/or  1 x max 100W - E27 Halo/Fluo	cat. B <b>150,00</b> cat. A <b>170,00</b> cat. Extra <b>180,00</b> cat. Club House <b>195,00</b>
 <b>9229-20-57</b> CYLINDER	200	41 x 41 x 53 h.	0,9	2,5	 1 x 10W LED - E27 oppure/or  1 x max 100W - E27 Halo/Fluo	cat. B <b>150,00</b> cat. A <b>170,00</b> cat. Extra <b>180,00</b> cat. Club House <b>195,00</b>
 <b>9229-20-58</b> CYLINDER	200	51 x 51 x 53 h.	0,95	2,6	 1 x 10W LED - E27 oppure/or  1 x max 100W - E27 Halo/Fluo	cat. B <b>155,00</b> cat. A <b>175,00</b> cat. Extra <b>185,00</b> cat. Club House <b>200,00</b>



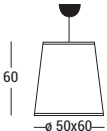







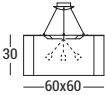

Lampadina esclusa / Bulb not included

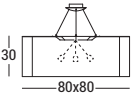

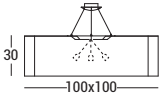

codice code	cavo elettrico cm electric cable cm	IMBALLO CM/PACKAGING CM SH = Shade ST = Structure	peso netto kg. net weight kg.	peso lordo kg. gross weight kg.	lampadina bulb	€ iva esclusa € tax not included
9229-20-59 CYLINDER		200	55 x 55 x 35 h.	1	3	cat. B <b>170,00</b>
						1 x 10W LED - E27 oppure/or 1 x max 100W - E27 Halo/Fluo
9229-20-60 CYLINDER		200	68 x 68 x 51 h.	1,3	5	cat. B <b>205,00</b>
						1 x 10W LED - E27 oppure/or 1 x max 100W - E27 Halo/Fluo
9229-20-61 CYLINDER		200	84 x 84 x 58 h.	1,4	6	cat. B <b>300,00</b>
						1 x 10W LED - E27 oppure/or 1 x max 100W - E27 Halo/Fluo
9229-20-62 CYLINDER		200	84 x 84 x 58 h.	3	11	cat. B <b>320,00</b>
						1 x 10W LED - E27 oppure/or 1 x max 100W - E27 Halo/Fluo

codice code	cavo elettrico cm electric cable cm	IMBALLO CM/PACKAGING CM SH = Shade ST = Structure	peso netto kg. net weight kg.	peso lordo kg. gross weight kg.	lampadina bulb	€ iva esclusa € tax not included		
9229-20-63 CYLINDER		<b>Variante a richiesta:</b> chiusura inferiore parziale in tessuto +10% <b>On demand:</b> partial fabric bottom closure +10%	200	107 x 107 x 62 h.	4	14	 3 x 10W LED - E27 oppure/or  3 x max 100W - E27 Halo/Fluo	cat. B <b>495,00</b>
								cat. A <b>580,00</b> cat. Extra <b>635,00</b> cat. Club House <b>695,00</b>
9229-20-40 DOUBLE CYLINDER			200	65 x 65 x 65 h.	3	6,5	 1 x 10W LED - E27 oppure/or  1 x max 100W - E27 Halo/Fluo	cat. B <b>350,00</b>
								cat. A <b>490,00</b> cat. Extra <b>535,00</b> cat. Club House <b>585,00</b>
9229-20-41 DOUBLE CYLINDER			200	87 x 87 x 58 h.	4	7	 3 x 10W LED - E27 oppure/or  3 x max 100W - E27 Halo/Fluo	cat. B <b>615,00</b>
								cat. A <b>680,00</b> cat. Extra <b>725,00</b> cat. Club House <b>755,00</b>
0604-20-64 LOW CYLINDER		Chiusura inferiore totale in plexiglass. Complete bottom closure in plexiglass.	200	65 x 65x 26 h.	3,5	6	 3 x 10W LED - E27 oppure/or  3 x max 100W - E27 Halo/Fluo	cat. B <b>450,00</b>
								cat. A <b>480,00</b> cat. Extra <b>525,00</b> cat. Club House <b>575,00</b>

codice code	cavo elettrico cm electric cable cm	IMBALLO CM/PACKAGING CM SH = Shade ST = Structure	peso netto kg. net weight kg.	peso lordo kg. gross weight kg.	lampadina bulb	€ iva esclusa € tax not included		
<b>0604-20-65</b> LOW CYLINDER		Chiusura inferiore totale in plexiglas. Complete bottom closure in plexiglas.	200	84 x 84 x 26 h.	4	9	lampadina bulb   3 x 10W LED - E27 oppure/or   3 x max 100W - E27 Halo/Fluo	cat. B <b>520,00</b> cat. A <b>540,00</b> cat. Extra <b>590,00</b> cat. Club House <b>645,00</b>
<b>0604-20-66</b> LOW CYLINDER		Chiusura inferiore totale in plexiglas. Complete bottom closure in plexiglas.	200	106 x 106 x 27 h.	6	10	lampadina bulb   3 x 10W LED - E27 oppure/or   3 x max 100W - E27 Halo/Fluo	cat. B <b>680,00</b> cat. A <b>695,00</b> cat. Extra <b>740,00</b> cat. Club House <b>810,00</b>
<b>0610-20-53</b> HIGH CYLINDER		Non realizzabile in canapa. Not available in hemp.	200	33 x 33 x 124 h.	2	4	lampadina bulb   1 x 10W LED - E27 oppure/or   1 x max 100W - E27 Halo/Fluo	cat. B <b>190,00</b> cat. A <b>250,00</b> cat. Extra <b>280,00</b> cat. Club House <b>305,00</b>
<b>0605-20-53</b> HIGH CYLINDER		Non realizzabile in canapa. Supporto a soffitto con saliscendi, contrappeso e cablaggio elettrico con alimentazione dal basso. Not available in hemp. Adjustable height system, hanging weight and electrical wiring with feeding from down.	200	33 x 33 x 124 h.	2	4	lampadina bulb   1 x 10W LED - E27 oppure/or   1 x max 100W - E27 Halo/Fluo	cat. B <b>295,00</b> cat. A <b>380,00</b> cat. Extra <b>415,00</b> cat. Club House <b>440,00</b>

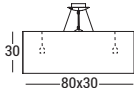
codice code	cavo elettrico cm electric cable cm	IMBALLO CM/PACKAGING CM SH = Shade ST = Structure	peso netto kg. net weight kg.	peso lordo kg. gross weight kg.	lampadina bulb	€ iva esclusa € tax not included
 <p><b>9229-20-31</b> LOW SEMICONE</p>	200	68 x 68 x 51 h.	1,2	4	 <p>1 x 10W LED - E27 oppure/or</p>  <p>1 x max 100W - E27 Halo/Fluo</p>	<p>cat. B <b>180,00</b></p> <p>cat. A <b>260,00</b></p> <p>cat. Extra <b>275,00</b></p> <p>cat. Club House <b>295,00</b></p>
 <p><b>9229-20-32</b> HIGH SEMICONE</p>	200	68 x 68 x 51 h.	1,2	4	 <p>1 x 10W LED - E27 oppure/or</p>  <p>1 x max 100W - E27 Halo/Fluo</p>	<p>cat. B <b>200,00</b></p> <p>cat. A <b>280,00</b></p> <p>cat. Extra <b>300,00</b></p> <p>cat. Club House <b>330,00</b></p>
 <p><b>9229-20-33</b> LARGE SEMICONE</p>	200	65 x 65 x 65 h.	2,5	5,2	 <p>1 x 10W LED - E27 oppure/or</p>  <p>1 x max 100W - E27 Halo/Fluo</p>	<p>cat. B <b>290,00</b></p> <p>cat. A <b>390,00</b></p> <p>cat. Extra <b>410,00</b></p> <p>cat. Club House <b>450,00</b></p>
 <p><b>9229-20-10</b> SQUARE</p> <p>Non realizzabile in PVC Not available in PVC</p>	200	55 x 55 x 35 h.	1,6	3	 <p>1 x 10W LED - E27 oppure/or</p>  <p>1 x max 100W - E27 Halo/Fluo</p>	<p>cat. B <b>160,00</b></p> <p>cat. A <b>175,00</b></p> <p>cat. Extra <b>185,00</b></p> <p>cat. Club House <b>200,00</b></p>

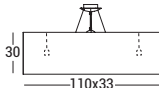
codice code		cavo elettrico cm electric cable cm	IMBALLO CM/PACKAGING CM SH = Shade ST = Structure	peso netto kg. net weight kg.	peso lordo kg. gross weight kg.	lampadina bulb	€ iva esclusa € tax not included
<b>1005-20-14D</b> SQUARE		200	67 x 67 x 51 h.	3,5	6,0	 3 x 10W LED - E27 oppure/or  3 x max 100W - E27 Halo/Fluo	cat. B <b>610,00</b> cat. A <b>640,00</b> cat. Extra <b>695,00</b> cat. Club House <b>765,00</b>
	Chiusura inferiore totale in plexiglas. Complete bottom closure in plexiglas.						cat. B <b>550,00</b> cat. A <b>580,00</b> cat. Extra <b>620,00</b> cat. Club House <b>680,00</b>
<b>1005-20-14</b> SQUARE	Chiusura inferiore parziale in tessuto. Partial fabric bottom closure.	200	67 x 67 x 51 h.	3,5	6,0	 3 x 10W LED - E27 oppure/or  3 x max 100W - E27 Halo/Fluo	cat. B <b>550,00</b> cat. A <b>580,00</b> cat. Extra <b>620,00</b> cat. Club House <b>680,00</b>
<b>1005-20-15D</b> SQUARE		200	87 x 87 x 58 h.	4,0	9,0	 3 x 10W LED - E27 oppure/or  3 x max 100W - E27 Halo/Fluo	cat. B <b>695,00</b> cat. A <b>750,00</b> cat. Extra <b>860,00</b> cat. Club House <b>945,00</b>
	Chiusura inferiore totale in plexiglas. Complete bottom closure in plexiglas.						cat. B <b>640,00</b> cat. A <b>680,00</b> cat. Extra <b>780,00</b> cat. Club House <b>840,00</b>
<b>1005-20-15</b> SQUARE	Chiusura inferiore parziale in tessuto. Partial fabric bottom closure.	200	87 x 87 x 58 h.	4,0	9,0	 3 x 10W LED - E27 oppure/or  3 x max 100W - E27 Halo/Fluo	cat. B <b>640,00</b> cat. A <b>680,00</b> cat. Extra <b>780,00</b> cat. Club House <b>840,00</b>
<b>1005-20-16D</b> SQUARE		200	107 x 107 x 62 h.	6,0	10,0	 3 x 10W LED - E27 oppure/or  3 x max 100W - E27 Halo/Fluo	cat. B <b>880,00</b> cat. A <b>920,00</b> cat. Extra <b>990,00</b> cat. Club House <b>1.085,00</b>
	Chiusura inferiore totale in plexiglas. Complete bottom closure in plexiglas.						cat. B <b>780,00</b> cat. A <b>810,00</b> cat. Extra <b>880,00</b> cat. Club House <b>965,00</b>
<b>1005-20-16</b> SQUARE	Chiusura inferiore parziale in tessuto. Partial fabric bottom closure.	200	107 x 107 x 62 h.	6,0	10,0	 3 x 10W LED - E27 oppure/or  3 x max 100W - E27 Halo/Fluo	cat. B <b>780,00</b> cat. A <b>810,00</b> cat. Extra <b>880,00</b> cat. Club House <b>965,00</b>

codice code	cavo elettrico cm electric cable cm	IMBALLO CM/PACKAGING CM SH = Shade ST = Structure	peso netto kg. net weight kg.	peso lordo kg. gross weight kg.	lampadina bulb	€ iva esclusa € tax not included		
1004-20-20 OVAL		<b>Variante a richiesta:</b> Chiusura inferiore parziale in tessuto +10%. <b>On demand:</b> Partial fabric bottom closure +10%.	200	100 x 37 x 44 h.	3,0	7,0	 2 x 10W LED - E27 oppure/or  2 x max 100W - E27 Halo/Fluo	cat. B <b>650,00</b>
								cat. A <b>680,00</b>
								cat. Extra <b>695,00</b>
								cat. Club House <b>740,00</b>
1004-20-21 OVAL		<b>Variante a richiesta:</b> Chiusura inferiore parziale in tessuto +10%. <b>On demand:</b> Partial fabric bottom closure +10%.	200	130 x 37 x 44 h.	4,0	9,0	 2 x 10W LED - E27 oppure/or  2 x max 100W - E27 Halo/Fluo	cat. B <b>730,00</b>
								cat. A <b>770,00</b>
								cat. Extra <b>825,00</b>
								cat. Club House <b>905,00</b>

Lampadina esclusa / Bulb not included

# Extra Large

Grazie alla flessibilità della nostra produzione, siamo in grado di sviluppare e realizzare anche progetti custom made.  
- Finitura plissé seta a mano e Club House - prezzo a richiesta







Thanks to the flexibility of our production, we are able to develop and realize also custom made projects.  
- Hand-made silk plissé and Club House finishing - price on demand

Dank an der Flexibilität unserer Produktion, sind wir in der Lage, Projekte Custom Made zu entwickeln und umsetzen.  
- Hand-fertigte Seide plissé und Club House Fertigbehandlung - Preise auf Verlangen

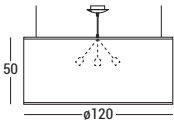

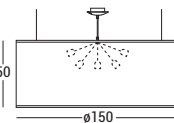

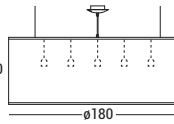

Merci à la flexibilité de notre production, nous sommes en mesure de développer et réaliser des projets custom made.  
- Finition plissé de soie à main et Club House - prix sur demande

Gracias a la flexibilidad de nuestra producción, somos capaces de desarrollar y realizar proyectos a medida.  
- Acabado plissé de seda hecho a mano y Club House - precio a pedido.

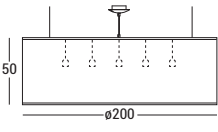
## Sospensioni Pendant

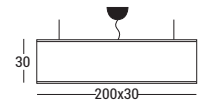
codice code	cavo elettrico cm electric cable cm	IMBALLO CM/PACKAGING CM SH = Shade ST = Structure	peso netto kg. net weight kg.	peso lordo kg. gross weight kg.	lampadina bulb	€ iva esclusa € tax not included		
1025-20-50 CYLINDER		Non realizzabile in PVC Not available in PVC	200	140 x 140 x 70 h.	6	18	cat. B 985,00 cat. A 1.030,00 cat. Extra 1.135,00	
	Chiusura inferiore parziale in tessuto. Partial fabric bottom closure.	Non realizzabile in PVC Not available in PVC	200	140 x 140 x 70 h.	6,4	18,4	3 x 10W LED - E27 oppure/or  3 x max 100W - E27 Halo/Fluo	cat. B 1.145,00 cat. A 1.300,00 cat. Extra 1.420,00
	Chiusura inferiore totale in plexiglas. Complete bottom closure in plexiglas.	Non realizzabile in PVC Not available in PVC	200	140 x 140 x 70 h.	7,3	19,3	cat. B 1.385,00 cat. A 1.480,00 cat. Extra 1.620,00	
1030-20-50 CYLINDER		Non realizzabile in PVC Not available in PVC	200	170 x 170 x 70 h.	8,0	27	cat. B 1.255,00 cat. A 1.325,00 cat. Extra 1.455,00	
	Chiusura inferiore parziale in tessuto max diam 130. Partial fabric bottom closure max diam 130.	Non realizzabile in PVC Not available in PVC	200	170 x 170 x 70 h.	8,5	27,5	5 x 10W LED - E27 oppure/or  5 x max 100W - E27 Halo/Fluo	cat. B 1.390,00 cat. A 1.465,00 cat. Extra 1.625,00
	Chiusura inferiore totale in plexiglas. Complete bottom closure in plexiglas.	Non realizzabile in PVC Not available in PVC	200	170 x 170 x 70 h.	10,0	29,0	cat. B 1.660,00 cat. A 1.765,00 cat. Extra 1.955,00	
1031-20-50 CYLINDER		Non realizzabile in PVC Not available in PVC	200	200 x 200 x 70 h.	14,0	36,0	cat. B 1.595,00 cat. A 1.640,00 cat. Extra 1.785,00	
	Chiusura inferiore parziale in tessuto max diam 130. Partial fabric bottom closure max diam 130.	Non realizzabile in PVC Not available in PVC	200	200 x 200 x 70 h.	14,8	36,8	8 x 10W LED - E27 oppure/or  8 x max 100W - E27 Halo/Fluo	cat. B 1.735,00 cat. A 1.785,00 cat. Extra 1.925,00
	Chiusura inferiore totale in plexiglas. Complete bottom closure in plexiglas.	Non realizzabile in PVC Not available in PVC	200	200 x 200 x 70 h.	17,0	39,0	cat. B 2.060,00 cat. A 2.175,00 cat. Extra 2.305,00	



codice code	cavo elettrico cm electric cable cm	IMBALLO CM/PACKAGING CM SH = Shade ST = Structure	peso netto kg. net weight kg.	peso lordo kg. gross weight kg.	lampadina bulb	€ iva esclusa € tax not included		
<b>1032-20-50</b> CYLINDER		Non realizzabile in PVC Not available in PVC	200	225 x 225 x 70 h.	18,0	41,0	cat. B <b>1.640,00</b> cat. A <b>1.775,00</b> cat. Extra <b>1.935,00</b>	
	Chiusura inferiore parziale in tessuto max diam 130. Partial fabric bottom closure max diam 130.	Non realizzabile in PVC Not available in PVC	200	225 x 225 x 70 h.	18,9	41,9	8 x 10W LED - E27 oppure/or  8 x max 100W - E27 Halo/Fluo 	cat. B <b>1.785,00</b> cat. A <b>1.915,00</b> cat. Extra <b>2.080,00</b>
	Chiusura inferiore totale in plexiglas. Complete bottom closure in plexiglas.	Non realizzabile in PVC Not available in PVC	200	225 x 225 x 70 h.	22,0	45,0	cat. B <b>2.230,00</b> cat. A <b>2.355,00</b> cat. Extra <b>2.520,00</b>	
<b>1033-20-80</b> RECTANGULAR		Non realizzabile in PVC Not available in PVC	200	220 x 45 x 40 h.	7,0	14,0	4 x 10W LED - E27 oppure/or  4 x max 100W - E27 Halo/Fluo 	cat. B <b>1.375,00</b> cat. A <b>1.460,00</b> cat. Extra <b>1.620,00</b>
	Chiusura inferiore totale in plexiglas. Complete bottom closure in plexiglas.	Non realizzabile in PVC Not available in PVC	200	270 x 45 x 40 h.	9,0	20,0	4 x 10W LED - E27 oppure/or  4 x max 100W - E27 Halo/Fluo 	cat. B <b>1.710,00</b> cat. A <b>1.775,00</b> cat. Extra <b>1.955,00</b>

**Lampadina esclusa / Bulb not included**

**PLAFONIERE SLIDE FUORI MISURA A PROGETTO** **CEILING SLIDE - EXTRA SIZE ON PROJECT**  
(DIAM 120-150-180-200) (DIAM 120-150-180-200)

Le spese di trasporto per le sospensioni speciali esulano dalle normali condizioni di trasporto pattuite (es. Porto Franco). L'importo di tale addebito sarà comunicato di volta in volta tramite conferma d'ordine.

Transport charges for Custom Made pendants lie outside usual delivery terms agreed (DDP). The amount of this cost will be advised from time to time in our order confirmation.

Frachtkosten für Custom Made Hängeleuchte gehen über unsere gewöhnliche Versandsbedingungen (Frei Haus) hinaus. Die Transportkosten für die Bestellungen dieser Artikeln werden von Zeit zur Zeit belasten und in unsere Auftragsbestätigung gezeigt.

Frais de transport pour suspensions Custom Made sortent de notre conditions de livraison habituelles (Port païé). Le cout du transport sera indiqué sur notre confirmation de temps en temps à la reception de commandes pour ces articles.

Los gastos de transporte para lámparas de suspensión especiales sobrepasan las normales condiciones de transporte acordadas (porte franco). El importe de tal adeudo será comunicado en su momento mediante la confirmación de pedido.

# Sospensioni PVC specchiato / Mirroring PVC pendants

Sospensioni con struttura in metallo rivestita con PVC specchiato lucido argento, nero o bronzo.

**A RICHIESTA:**  
- estensione cablaggio elettrico

Pendants with metal structure covered with glossy mirroring PVC in the colours silver, black or bronze.

**ON DEMAND:**  
- longer electrical and hanging cables

Hängeleuchten mit Struktur aus Metall mit glänzendem Spiegel-PVC in den Farben Silber, Schwarz oder Bronze bezogen.

**AUF VERLANGEN:**  
- längere elektrische und Hangkabel



Suspensions avec structure en métal revêtue avec PVC réfléchissant dans les couleurs argent, noir ou bronze.

**SUR DEMANDE:**  
- câbles électriques et de suspension plus longs

Lámparas de techo con estructura en metal recubierta en PVC espejado en los colores plata, negro o bronce.

**A PEDIDO:**  
- cables eléctricos y colgantes más largos

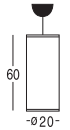
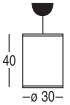
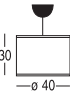
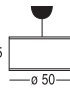
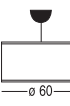
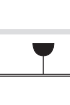
Sospensioni Pendant

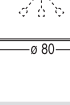
codice code		cavo elettrico cm electric cable cm	IMBALLO CM/PACKAGING CM SH = Shade ST = Structure	peso netto kg. net weight kg.	peso lordo kg. gross weight kg.	lampadina bulb	€ iva esclusa € tax not included
<b>0905-20-54</b> CYLINDER		200	31 x 31 x 82 h.	1,0	2,4	1x10W LED - E27 oppure/or 1xmax 100W - E27 Halo/Fluo	<b>270,00</b>
<b>0905-20-57</b> CYLINDER		200	41 x 41 x 53 h.	0,9	2,5	1x10W LED - E27 oppure/or 1xmax 100W - E27 Halo/Fluo	<b>270,00</b>
<b>0905-20-58</b> CYLINDER		200	51 x 51 x 53 h.	0,95	2,6	1x10W LED - E27 oppure/or 1xmax 100W - E27 Halo/Fluo	<b>270,00</b>
<b>0905-20-59</b> CYLINDER		200	55 x 55 x 35 h.	1	3	1x10W LED - E27 oppure/or 1xmax 100W - E27 Halo/Fluo	<b>310,00</b>
<b>0905-20-60</b> CYLINDER		200	68 x 68 x 51 h.	1,3	5	1x10W LED - E27 oppure/or 1xmax 100W - E27 Halo/Fluo	<b>370,00</b>
<b>0905-20-61</b> CYLINDER		200	84 x 84 x 58 h.	1,4	6	1x10W LED - E27 oppure/or 1xmax 100W - E27 Halo/Fluo	<b>435,00</b>
<b>0905-20-62</b> CYLINDER		200	84 x 84 x 58 h.	3	11	3x10W LED - E27 oppure/or 3xmax 100W - E27 Halo/Fluo	<b>585,00</b>
<b>0905-20-63</b> CYLINDER		200	107 x 107 x 62 h.	4	14	3x10W LED - E27 oppure/or 3xmax 100W - E27 Halo/Fluo	<b>680,00</b>

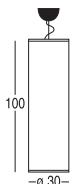
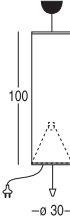
codice code	cavo elettrico cm electric cable cm	IMBALLO CM/PACKAGING CM SH = Shade ST = Structure	peso netto kg. net weight kg.	peso lordo kg. gross weight kg.	lampadina bulb	€ iva esclusa € tax not included
<b>0910-20-53</b> HIGH CYLINDER		33 x 33 x 124 h.	2	4	1x10W LED - E27 oppure/or 1xmax 100W - E27 Halo/Fluo	<b>345,00</b>
<b>0905-20-53</b> HIGH CYLINDER	 Supporto a soffitto con saliscendi, contrappeso e cablaggio elettrico con alimentazione dal basso. <i>Adjustable height system, hanging weight and electrical wiring with feeding from down.</i>	33 x 33 x 124 h.	2	4	1x10W LED - E27 oppure/or 1xmax 100W - E27 Halo/Fluo	<b>470,00</b>

Lampadina esclusa / Bulb not included

# Club House

Sospensioni con struttura in metallo rivestite in linone o raso di seta con passamaneria in contrasto.

Cavo elettrico in cotone colorato: arancio, turchese e blu. Rosone bianco escluso.

**A richiesta: su progetto composizioni, rosoni**  
- estensione cablaggio elettrico € 9,00/mt + IVA

Pendants with metal structure covered with lawn and silk satin with clashing trimmings.

Electrical cable in cotton in colours orange, turquoise, blue.

White metal canopy excluded.  
**On demand: for projects compositions, canopies**  
- longer electrical and hanging cable € 9,00/mt

Hängeleuchte mit Struktur aus Metall mit Leinen oder Seide Satin mit gegensätzlicher Posament bezogen.

Elektrische Kabel aus Baumwolle in Farbe orange, tuerkisblau, blau. Deckbefestigung aus weissem lackiertem Metall.

**Auf Verlangen: Fuer Projekten Zusammensetzungen, Deckbefestigungen.**  
- längere elektrische und Hangkabel € 9,00/mt

Suspension avec structure en métal revetue avec lin ou soie satin avec garniture en contraste.

Cablage électrique en coton dans les couleurs orange, turquoise, bleu.

Rosace en métal verni blanc.  
**Sur demande: Pour projects compositions, rosaces.**  
- câble électrique et de suspension plus long € 9,00/mt

Lamparas de techo con estructura en metal recubierto en lino o raso de seda con pasamaneria en contraste.

Cableado eléctrico en algodón naranja, turquesa, azul.

Roseton en metal lacado blanco.

**A pedido: Por proyectos composicion, rosetones y extra cableado**  
- cable electrico y colgante más largo € 9,00/mt

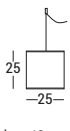
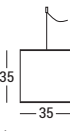
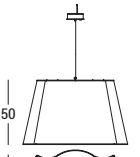
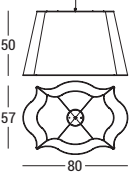
codice code		cavo elettrico cm electric cable cm	IMBALLO CM/PACKAGING CM SH = Shade ST = Structure	peso netto kg. net weight kg.	peso lordo kg. gross weight kg.	lampadina bulb	€ iva esclusa € tax not included
1402-20-01		200	31 x 31 x 62 h.	0,9	2	1x10W LED - E27 oppure/or 1xmax 100W - E27 Halo/Fluo	145,00
1402-20-02		200	31 x 31 x 62 h.	0,9	2	1x10W LED - E27 oppure/or 1xmax 100W - E27 Halo/Fluo	155,00
1402-20-03		200	40 x 40 x 53 h.	1,20	2,4	1x10W LED - E27 oppure/or 1xmax 100W - E27 Halo/Fluo	170,00
<b>TRENDY</b>							
1402-20-10 LARGE		200	84 x 84 x 55 h. <b>LARGE</b>	3	9	3x10W LED - E27 oppure/or 3xmax 100W - E27 Halo/Fluo	LARGE 980,00
1402-20-11 SMALL		200	66 x 66 x 48 h. <b>SMALL</b>	2	7	1x10W LED - E27 oppure/or 1xmax 100W - E27 Halo/Fluo	SMALL 460,00

Lampadina esclusa / Bulb not included

codice  
codeIMBALLO CM/PACKAGING CM  
SH = Shade ST = Structure€ iva esclusa  
€ tax not included**ROSONI/CANOPIES**

Disponibili con 1, 2, 3, 4, 8 fori / Available with 1,2,3,4,8 fittings

**1402-20-A-V2**  
BIANCO/WHITE**1402-20-A-T1**  
TITANIO/TITANIUM

31 x 31 x 32 h.

bianco  
whitetitanio  
titanium

65,00

90,00

**1402-20-B-V2**  
BIANCO/WHITE**1402-20-B-T1**  
TITANIO/TITANIUM

31 x 31 x 32 h.

70,00

95,00

**1402-20-C-V2**  
BIANCO/WHITE**1402-20-C-T1**  
TITANIO/TITANIUM

31 x 31 x 32 h.

75,00

100,00

**1402-20-D-V2**  
BIANCO/WHITE**1402-20-D-T1**  
TITANIO/TITANIUM

31 x 31 x 32 h.

80,00

105,00

**1402-20-E-V2**  
BIANCO/WHITE**1402-20-E-T1**  
TITANIO/TITANIUM

31 x 31 x 32 h.

90,00

115,00

**Decentramento cavo elettrico/Canopy to decentralize**DECENTRAMENTO  
Bianco/Titanio  
White/Titaniumbianco  
whitetitanio  
titanium

20,00

25,00

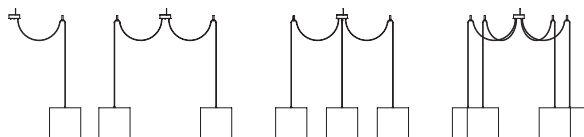
**Esempi composizioni/Cluster examples**Attenzione: filo elettrico standard mt. 2, a richiesta cavo più lungo  
Attn: standard electrical cable mts. 2, on demand longer cable**SU PROGETTO A RICHIESTA ROSONI E  
COMPOSIZIONI PERSONALIZZATE  
ON DEMAND SPECIAL CANOPIES  
AND COMPOSITIONS FOR CUSTOM  
PROJECTS**

# Club House

Appliques con struttura in metallo rivestite in linone o raso di seta con passamaneria in contrasto o nei tessuti della collezione: (Escluso PVC specchiato e plissé seta a mano)

**Supporto a muro grigio metallizzato compreso.**

Wall lamps with metal structure covered with lawn and silk satin with clashing trimmings or in the fabrics of the collection (mirroring PVC and hand-made silk plissé excluded)

**Metallic grey wall support included.**

Wandleuchte mit Struktur aus Metall mit Leinen oder Seide Satin mit gegensätzlicher Posament bezogen oder in den Stoffe der Kollektion (Spiegel-PVC und handgefertigte seide plissé nicht einschliesslich)

**Metallic grau Wandbefestigung einschliesslich**

Appliques avec structure en métal revêtue avec lin ou soie satin avec garniture en contraste ou avec les tissus de la collection (PVC réfléchissant et plissé de soie a man pas inclus)

**Support à mur en gris métallisé inclus.**

Appliques con estructura en metal recubierto en lino o raso de seda con pasamaneria en contraste o con los tejidos de la colección (excepto PVC espejado y plissé de seda hecho a mano)

**Estructura a pared gris metallizado incluida.**

1402

Applique Wall

codice code		cavo elettrico cm electric cable cm	IMBALLO CM/PACKAGING CM SH = Shade ST = Structure	peso netto kg. net weight kg.	peso lordo kg. gross weight kg.	lampadina bulb	€ iva esclusa € tax not included
1402-30-01			55 x 40 x 35 h.	0,4	1,8	1x10W LED - E27 oppure/or 1xmax 100W - E27 Halo/Fluo	cat. B <b>165,00</b> cat. A <b>170,00</b> cat. Extra <b>175,00</b> cat. Club House <b>180,00</b>
1402-30-02			55 x 40 x 35 h.	0,4	1,8	1x10W LED - E27 oppure/or 1xmax 100W - E27 Halo/Fluo	cat. B <b>180,00</b> cat. A <b>185,00</b> cat. Extra <b>190,00</b> cat. Club House <b>195,00</b>
1402-30-06			55 x 40 x 35 h.	0,5	2	1x10W LED - E27 oppure/or 1xmax 100W - E27 Halo/Fluo	cat. B <b>205,00</b> cat. A <b>210,00</b> cat. Extra <b>215,00</b> cat. Club House <b>220,00</b>
1402-30-07			55 x 40 x 35 h.	0,5	2	1x10W LED - E27 oppure/or 1xmax 100W - E27 Halo/Fluo	cat. B <b>200,00</b> cat. A <b>210,00</b> cat. Extra <b>215,00</b> cat. Club House <b>230,00</b>
1402-30-11			30 x 45 x 65 h.	0,7	3	1x10W LED - E27 oppure/or 1xmax 100W - E27 Halo/Fluo	cat. B <b>215,00</b> cat. A <b>220,00</b> cat. Extra <b>225,00</b> cat. Club House <b>245,00</b>

**Lampadina esclusa / Bulb not included**

# Luxury

Sospensioni con struttura metallica rivestita nei tessuti della collezione. **Escluso PVC specchiato.**

Cablaggio elettrico con rosone nichel satinato, cavo acciaio e filo trasparente.

**Chiusura inferiore parziale in plexiglas.**

**A RICHIESTA:**

- estensione cablaggio elettrico

Pendants with metallic structure covered with the fabrics of the collection. **Mirroring PVC excluded.**

Electrical wiring with nickel satin canopy, steel hanging cable and transparent electrical cable.

**Partial bottom closure in plexiglas.**

**ON DEMAND:**

- longer electrical and hanging cables

Hängeleuchte mit Struktur aus Metal und Schirm in den Stoffen der Kollektion. **Spiegel-PVC nicht einschliesslich.**

Elektrische Verkabelung mit Deckbefestigung Nickel satiniert, Hängkabel aus Stahl und Transparent-elektrischkabel.

**Teilabdeckung aus Plexiglas.**

**AUF VERLANGEN:**

- längere elektrische und Hängkabel

Suspensions avec structure en metal revêtue avec les tissus de la collection. **PVC réfléchissant pas inclus.**

Câblage électrique avec rosace en nickel satiné, câble de support en acier et câble électrique transparent.

**Fermeture inférieure partielle en plexiglas.**

**SUR DEMANDE:**

- câbles électriques et de suspension plus longs

Lámparas de techo con estructura metálica producidas con los tejidos de la colección. **Excepto PVC espejado.**

Cableado eléctrico con rosseton níquel satinado, cable de fijación en acero y cable eléctrico transparente.









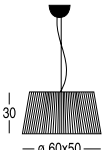

**Cierre inferior parcial en plexiglas.**

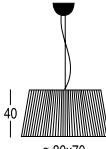
**A PEDIDO:**

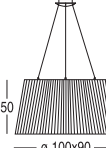

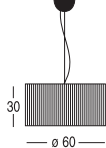

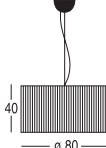

- cables eléctricos y colgantes más largos

0607

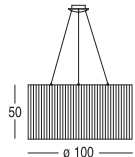
Sospensioni Pendant

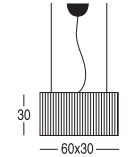
codice code		cavo elettrico cm electric cable cm	IMBALLO CM/PACKAGING CM SH = Shade ST = Structure	peso netto kg. net weight kg.	peso lordo kg. gross weight kg.	lampadina bulb	€ iva esclusa € tax not included
<b>0607-20-33</b> SEMICONE		200	68 x 68 x 51 h.	3	6	 3 x 10W LED - E27 oppure/or  3 x max 100W - E27 Halo/Fluo	cat. B <b>420,00</b> cat. A <b>480,00</b> cat. Plissé seta a mano/Extra <b>520,00</b> cat. Club House <b>570,00</b>
<b>0607-20-34</b> SEMICONE		200	84 x 84 x 58 h.	4	12	 3 x 10W LED - E27 oppure/or  3 x max 100W - E27 Halo/Fluo	cat. B <b>570,00</b> cat. A <b>680,00</b> cat. Plissé seta a mano/Extra <b>760,00</b> cat. Club House <b>835,00</b>
<b>0607-20-35</b> SEMICONE		200	107 x 107 x 62 h.	5	15	 3 x 10W LED - E27 oppure/or  3 x max 100W - E27 Halo/Fluo	cat. B <b>740,00</b> cat. A <b>870,00</b> cat. Plissé seta a mano/Extra <b>980,00</b> cat. Club House <b>1.075,00</b>
<b>0607-20-60</b> CYLINDER		200	68 x 68 x 51 h.	3	6	 3 x 10W LED - E27 oppure/or  3 x max 100W - E27 Halo/Fluo	cat. B <b>420,00</b> cat. A <b>480,00</b> cat. Plissé seta a mano/Extra <b>520,00</b> cat. Club House <b>570,00</b>
<b>0607-20-62</b> CYLINDER		200	84 x 84 x 58 h.	4	12	 3 x 10W LED - E27 oppure/or  3 x max 100W - E27 Halo/Fluo	cat. B <b>570,00</b> cat. A <b>680,00</b> cat. Plissé seta a mano/Extra <b>760,00</b> cat. Club House <b>835,00</b>

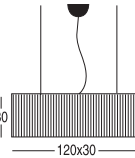
Lampadina esclusa / Bulb not included

codice code	cavo elettrico cm electric cable cm	IMBALLO CM/PACKAGING CM SH = Shade ST = Structure	peso netto kg. net weight kg.	peso lordo kg. gross weight kg.	lampadina bulb	€ iva esclusa € tax not included		
<b>0607-20-63</b> CYLINDER		200 107 x 107 x 62 h.	5	15	 3 x 10W LED - E27 oppure/or  3 x max 100W - E27 Halo/Fluo	cat. B <b>740,00</b> cat. A <b>870,00</b> cat. Plissé seta a mano/Extra <b>980,00</b> cat. Club House <b>1.075,00</b>		
<b>0607-20-83</b> RECTANGULAR		Chiusura inferiore totale in plexiglas. Complete bottom closure in plexiglas.	200	80 x 37 x 44 h.	2,3	8	 2 x 10W LED - E27 oppure/or  2 x max 100W - E27 Halo/Fluo	cat. B <b>495,00</b> cat. A <b>525,00</b> cat. Plissé seta a mano/Extra <b>785,00</b> cat. Club House <b>865,00</b>
<b>0607-20-84</b> RECTANGULAR		Chiusura inferiore totale in plexiglas. Complete bottom closure in plexiglas.	200	141 x 37 x 44 h.	4,5	9	 3 x 10W LED - E27 oppure/or  3 x max 100W - E27 Halo/Fluo	cat. B <b>650,00</b> cat. A <b>710,00</b> cat. Plissé seta a mano/Extra <b>995,00</b> cat. Club House <b>1.080,00</b>

**Lampadina esclusa / Bulb not included**



# Slide

Lampade da soffitto e parete con struttura in metallo, rivestite con i tessuti della collezione. **Escluso PVC specchiato.** Chiusura inferiore totale in plexiglas.

Ceiling and wall lamps with metal structure, covered with the fabrics of the collection. **Mirroring PVC excluded.** Complete bottom closure in plexiglas.











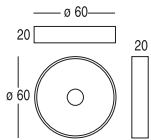

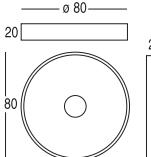
Deck- und Wandleuchten mit Struktur aus Metall, mit den Stoffen der Kollektion bezogen. **Spiegel-Pvc nicht einschliesslich.** Ganze Unterabdeckung aus Plexiglas.

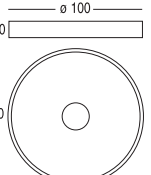
Plafoniers at appliques avec structure en métal, revêtus dans les tissus de la collection. **PVC réfléchissant pas inclus.** Fermeture inférieure complète en plexiglas.

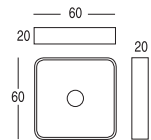
Plafones y apliques con estructura en metal, recubiertas con los tejidos de la colección. **Excepto pvc espejado.** Cierre inferior total en plexiglas.

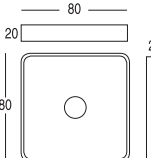
0604

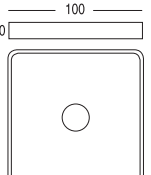
Applique/Plafoniera Wall/ Ceiling

codice code		cavo elettrico cm electric cable cm	IMBALLO CM/PACKAGING CM SH = Shade ST = Structure	peso netto kg. net weight kg.	peso lordo kg. gross weight kg.	lampadina bulb	€ iva esclusa € tax not included
<b>0604-40-64</b> SMALL ROUND			67 x 67 x 28 h.	3,5	6,5	 3 x 10W LED - E27 oppure/or  3 x max 100W - E27 Halo/Fluo	cat. B <b>440,00</b>  cat. A <b>460,00</b>  cat. Extra <b>500,00</b>
<b>0604-40-65</b> MEDIUM ROUND			87 x 87 x 27 h.	4	10	 3 x 10W LED - E27 oppure/or  3 x max 100W - E27 Halo/Fluo	cat. B <b>520,00</b>  cat. A <b>550,00</b>  cat. Extra <b>600,00</b>
<b>0604-40-66</b> LARGE ROUND			106 x 106 x 27 h.	6,5	14	 3 x 10W LED - E27 oppure/or  3 x max 100W - E27 Halo/Fluo	cat. B <b>570,00</b>  cat. A <b>595,00</b>  cat. Extra <b>655,00</b>
<b>1005-40-14</b> SMALL SQUARE			67 x 67 x 27 h.	3,5	6,5	 3 x 10W LED - E27 oppure/or  3 x max 100W - E27 Halo/Fluo	cat. B <b>480,00</b>  cat. A <b>510,00</b>  cat. Extra <b>540,00</b>
<b>1005-40-15</b> MEDIUM SQUARE			87 x 87 x 27 h.	4	10	 3 x 10W LED - E27 oppure/or  3 x max 100W - E27 Halo/Fluo	cat. B <b>585,00</b>  cat. A <b>635,00</b>  cat. Extra <b>685,00</b>
<b>1005-40-16</b> LARGE SQUARE			107 x 107 x 27 h.	6,5	14	 3 x 10W LED - E27 oppure/or  3 x max 100W - E27 Halo/Fluo	cat. B <b>685,00</b>  cat. A <b>725,00</b>  cat. Extra <b>795,00</b>

Lampadina esclusa / Bulb not included

# Up-Down

Sospensione in metallo con diffusore in PVC specchiato o nei tessuti della collezione, **escluso plissé seta a mano**. Sali scendi regolabile, contrappeso e cablaggio elettrico con alimentazione dal basso.

Metal pendant with shade in mirroring PVC or in the fabrics of the collection, **hand made silk plissé excluded**. Adjustable height system with weight and electrical wiring with power supply from down.



Hängeleuchte aus Metall mit Schirm aus Spiegel PVC oder aus Stoffen von unsere Kollektion, **handgefertigte seide plissé nicht einschlieslich**. Höhen verstellbar mit Gewichts und elektrische Leitungen mit der Fütterung von unten.

Suspension en Métal avec abat-jour en PVC réfléchissant ou dans les tissus de la collection, **plissé de soie à main pas inclus**. Système de hauteur réglable avec le poids et le câblage électrique à l'alimentation du bas.

Suspensiones en metal con difusor en pvc espejado o en los tejidos de la colección, **excepto pliss de seda hecho a mano**. Subida y bajada regulable, contrapeso y cableado eléctrico con alimentación desde la parte de abajo.

1009

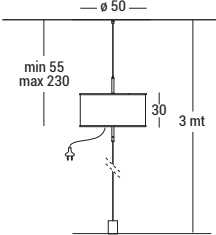
Sospensioni Pendant

codice code	cavo elettrico cm electric cable cm	IMBALLO CM/PACKAGING CM SH = Shade ST = Structure	peso netto kg. net weight kg.	peso lordo kg. gross weight kg.	lampadina bulb	€ iva esclusa € tax not included
1009-20	200		1,3	3,0	 3 x 5W LED - E14 oppure/or	cat. B <b>595,00</b>
			4,9	9,0	 3 x max 42W - E14 Halo/Fluo	cat. A <b>605,00</b> cat. Extra <b>630,00</b>

Lampadina esclusa / Bulb not included

# Vanity

Appliques con struttura in metallo rivestita con i tessuti della collezione. Supporto a muro grigio metallizzato compreso.

Wall lamps with metal structure covered with the fabrics of the collection. Metallic grey wall support included.





Wandleuchte mit Struktur aus Metall und Schirm aus den Stoffen der Kollektion. Metallisch grau Wandbefestigung einschließlic.

Appliques avec structure en métal revêtu avec les tissus de la collection. Support à mur en gris métallisé inclus.

Appliques con estructura en metal recubierto en los tejidos de la colección. Estructura a pared gris metallizado incluida.

9540

Applique Wall

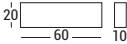
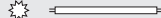
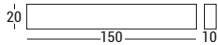
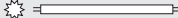
codice code	cavo elettrico cm electric cable cm	IMBALLO CM/PACKAGING CM SH = Shade ST = Structure	peso netto kg. net weight kg.	peso lordo kg. gross weight kg.	lampadina bulb	€ iva esclusa € tax not included
<b>9540-30-86</b> LARGE RECTANGULAR		55 x 42 x 37 h.	0,9	2	1x10W LED - E27 oppure/or 1xmax 100W - E27 Halo/Fluo	cat. A-B <b>185,00</b> cat. Extra /plissé seta a mano hand made silk plissé <b>285,00</b>
<b>9540-30-85</b> SMALL RECTANGULAR		31 x 31 x 32 h.	0,5	1,50	1x5W LED - E14 oppure/or 1xmax 60W - E14 Halo/Fluo	cat. A-B <b>160,00</b> cat. Extra /plissé seta a mano hand made silk plissé <b>235,00</b>
<b>9540-30-02</b> LARGE ROUND		55 x 42 x 37 h.	0,9	2	1x10W LED - E27 oppure/or 1xmax 100W - E27 Halo/Fluo	cat. A-B <b>185,00</b> cat. Extra /plissé seta a mano hand made silk plissé <b>285,00</b>
<b>9540-30-01</b> SMALL ROUND		31 x 31 x 32 h.	0,5	1,50	1x5W LED - E14 oppure/or 1xmax 60W - E14 Halo/Fluo	cat. A-B <b>160,00</b> cat. Extra /plissé seta a mano hand made silk plissé <b>235,00</b>
<b>Lampadina esclusa / Bulb not included</b>						
<b>0807-30-85</b> SMALL LINEAR	 Chiusura superiore e inferiore totale in plexiglass Complete upper and bottom closure in plexiglass	70 x 20 x 30 h.	1,5	4,5	Lampadina inclusa/ Bulb included  1T5 x 14W Fluo	cat. B <b>345,00</b> cat. A <b>360,00</b> cat. Extra /plissé seta a mano hand made silk plissé <b>410,00</b>
<b>0807-30-86</b> LARGE LINEAR	 Chiusura superiore e inferiore totale in plexiglass Complete upper and bottom closure in plexiglass	160 x 20 x 30 h.	3,8	7,5	Lampadina inclusa/ Bulb included  2T5 x 49W Fluo	cat. B <b>560,00</b> cat. A <b>610,00</b> cat. Extra /plissé seta a mano hand made silk plissé <b>635,00</b>

 = lampadina compresa solo per 230 V~(NO 110V~)  
bulb included only for 230V~ (NOT 110V~)



# Piastre/*Plates* (Escluso art. Wonder/*art. Wonder excluded*)

Piastra in metallo nelle finiture: titanio o laccata bianca.











Metal plate in the finishes: titanium or white lacquered.

Platte aus Metall in den Farben: Titanium oder weissem lackiert.

Plaque en metal dans les couleurs: titanium ou laqué blanche.

Acabado placa titanium o blanco lacado.

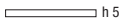
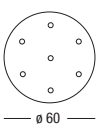
Piastre Plates

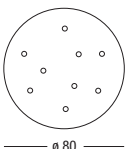
codice code	cavo elettrico cm electric cable cm	IMBALLO CM/PACKAGING CM SH = Shade ST = Structure	peso netto kg. net weight kg.	peso lordo kg. gross weight kg.	€ iva esclusa € tax not included	
					bianco white	titanio titanium
<b>0811-27-V2</b> BIANCO/WHITE <b>0811-27-T1</b> TITANIO/TITANIUM ROUND PLATE MAX 3 FITTINGS	 h 5  - ø 42 -	55 x 55 x 15 h.	3,5	5,5	210,00	240,00
<b>0001-T-30-03-V2</b> BIANCO/WHITE <b>0001-T-30-03-T1</b> TITANIO/TITANIUM ROUND PLATE MAX 3 FITTINGS	<b>PIASTRE ELETTRIFICATE ELECTRIFIED PLATES</b>  h 5  - ø 30 -	39 x 39 x 15 h.	3	4	270,00	310,00
<b>0002-T-42-05-V2</b> BIANCO/WHITE <b>0002-T-42-05-T1</b> TITANIO/TITANIUM ROUND PLATE MAX 5 FITTINGS	 h 5  - ø 42 -	55 x 55 x 15 h.	3,5	5,5	365,00	420,00
<b>0003-T-42-07-V2</b> BIANCO/WHITE <b>0003-T-42-07-T1</b> TITANIO/TITANIUM ROUND PLATE MAX 7 FITTINGS	 h 5  - ø 42 -	55 x 55 x 15 h.	4,5	6	445,00	510,00
<b>0004-T-60-07-V2</b> BIANCO/WHITE <b>0004-T-60-07-T1</b> TITANIO/TITANIUM ROUND PLATE MAX 7 FITTINGS	 h 5  - ø 60 -	67 x 67 x 28 h.	9	12	540,00	620,00
<b>0005-T-80-09-V2</b> BIANCO/WHITE <b>0005-T-80-09-T1</b> TITANIO/TITANIUM ROUND PLATE MAX 9 FITTINGS	 h 5  - ø 80 -	87 x 87 x 28 h.	17	20	720,00	830,00

PIASTRE E ROSONI/PLATES AND CANOPIES

codice code		IMBALLO CM/PACKAGING CM SH = Shade ST = Structure	peso netto kg. net weight kg.	peso lordo kg. gross weight kg.	€ iva esclusa € tax not included	bianco white	titanio titanium
<b>0006-T-80-13-V2</b> BIANCO/WHITE <b>0006-T-80-13-T1</b> TITANIO/TITANIUM  ROUND PLATE MAX 13 FITTINGS		87 x 87 x 28 h.	17	20	860,00	990,00	
<b>0007-T-100-17-V2</b> BIANCO/WHITE <b>0007-T-100-17-T1</b> TITANIO/TITANIUM  ROUND PLATE MAX 17 FITTINGS		106 x 106 x 28 h.	25	28	1.170,00	1.345,00	
<b>0008-L-92-V2</b> BIANCO/WHITE <b>0008-L-92-T1</b> TITANIO/TITANIUM  LINEAR PLATE MAX 8 FITTINGS		100 x 30 x 30 h.	7	9	415,00	480,00	
<b>0009-L-138-V2</b> BIANCO/WHITE <b>0009-L-138-T1</b> TITANIO/TITANIUM  LINEAR PLATE MAX 8 FITTINGS		160 x 20 x 30 h.	10	13	610,00	700,00	
<b>0010-R-90-07-V2</b> BIANCO/WHITE <b>0010-R-90-07-T1</b> TITANIO/TITANIUM  RECTANGULAR PLATE MAX 7 FITTINGS		110 x 60 x 15 h.	16	18	680,00	785,00	

codice  
codeIMBALLO CM/PACKAGING CM  
SH = Shade ST = Structure€ iva esclusa  
€ tax not included**ROSONI/CANOPIES**

Disponibili con 1, 2, 3, 4, 8 fori / Available with 1,2,3,4,8 fittings

**1402-20-A-V2**  
BIANCO/WHITE**1402-20-A-T1**  
TITANIO/TITANIUM

31 x 31 x 32 h.

bianco  
whitetitanio  
titanium

65,00

90,00

**1402-20-B-V2**  
BIANCO/WHITE**1402-20-B-T1**  
TITANIO/TITANIUM

31 x 31 x 32 h.

70,00

95,00

**1402-20-C-V2**  
BIANCO/WHITE**1402-20-C-T1**  
TITANIO/TITANIUM

31 x 31 x 32 h.

75,00

100,00

**1402-20-D-V2**  
BIANCO/WHITE**1402-20-D-T1**  
TITANIO/TITANIUM

31 x 31 x 32 h.

80,00

105,00

**1402-20-E-V2**  
BIANCO/WHITE**1402-20-E-T1**  
TITANIO/TITANIUM

31 x 31 x 32 h.

90,00

115,00

**Decentramento cavo elettrico/Canopy to decentralize**DECENTRAMENTO  
Bianco/Titanio  
White/Titaniumbianco  
whitetitanio  
titanium

20,00

25,00

# Piastre per art. Wonder / Plates for art. Wonder

Piastre in metallo nella  
finitura laccata bianca con  
alimentatore.

Metal plate in the finish white  
lacquered with power source.

Platte aus weissem lackiertem  
Metall mit Netzanschlussgerät.

Plaque en metal laqué  
blanche avec alimentateur.

Placa en metal blanco lacado  
con alimentador.

Piastre Plates

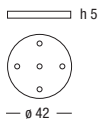
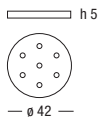
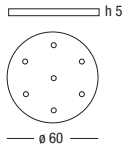
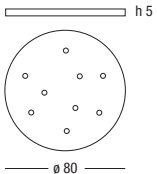
codice code	cavo elettrico cm electric cable cm	IMBALLO CM/PACKAGING CM SH = Shade ST = Structure	peso netto kg. net weight kg.	peso lordo kg. gross weight kg.	€ iva esclusa € tax not included	
<b>1504-T-30-03</b> ROUND PLATE MAX 3 FITTINGS			39 x 39 x 15 h.	3	4	295,00
<b>1504-T-42-05</b> ROUND PLATE MAX 5 FITTINGS			55 x 55 x 15 h.	3,5	5,5	415,00
<b>1504-T-42-07</b> ROUND PLATE MAX 7 FITTINGS			55 x 55 x 15 h.	4,5	6	525,00
<b>1504-T-60-07</b> ROUND PLATE MAX 7 FITTINGS			67 x 67 x 28 h.	9	12	615,00
<b>1504-T-80-09</b> ROUND PLATE MAX 9 FITTINGS			87 x 87 x 28 h.	17	20	825,00



codice code	cavo elettrico cm electric cable cm	IMBALLO CM/PACKAGING CM SH = Shade ST = Structure	peso netto kg. net weight kg.	peso lordo kg. gross weight kg.	€ iva esclusa € tax not included
<b>1504-T-80-13</b> ROUND PLATE MAX 13 FITTINGS		87 x 87 x 28 h.	17	20	1.020,00
<b>1504-T-100-17</b> ROUND PLATE MAX 17 FITTINGS		106 x 106 x 28 h.	25	28	1.360,00
<b>1504-L-92</b> LINEAR PLATE MAX 8 FITTINGS		100 x 30 x 30 h.	7	9	490,00
<b>1504-L-138</b> LINEAR PLATE MAX 8 FITTINGS		160 x 20 x 30 h.	10	13	675,00
<b>1504-R-90-07</b> RECTANGULAR PLATE MAX 7 FITTINGS		110 x 60 x 15 h.	16	18	760,00

# Rosoni / Canopies

Specifiche del sistema di installazione a plafone

Specification of installation system to ceiling

Verzeichnis von deckbefestigungsaufbauinstallation

Specification pour l'installation du système de fixation au plafond

Especificaciones del sistema de instalación a plafón

Rosoni Canopies

codice  
code

**BALOOON**  
**SOSPENSIONI**  
**TESSUTO**  
**SATINATO**



**C'HI**  
**SATINATO**

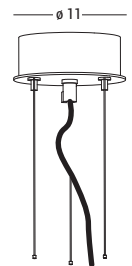

**BODONA**  
**VERNICIATO**  
**ARGENTO**

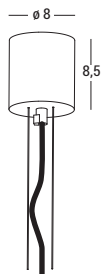

**C'HI MAXI**  
**SATINATO**

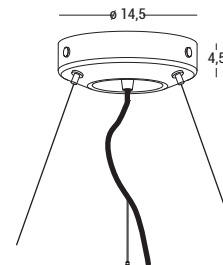

**BRIDGET**  
**ORIENTABILE/**  
**ADJUSTABLE**  
**SATINATO**

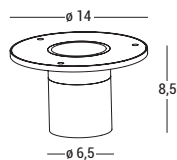

**CRYON**  
**SMALL**  
**SATINATO**

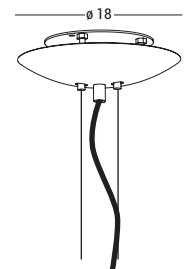

**CLUB HOUSE**  
**TRENDY**  
**MAMI SINGOLA**  
**KASKADE**

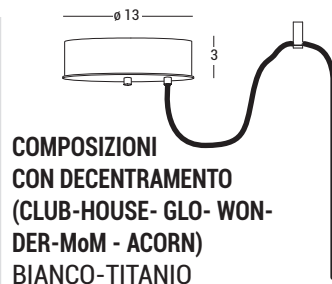
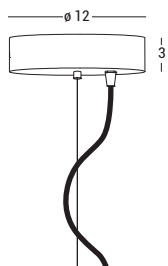

**COMPOSIZIONI**  
**CON DECENTRAMENTO**  
**(CLUB-HOUSE- GLO- WON-**  
**DER-MoM - ACORN)**  
**BIANCO-TITANIO**

**CRYON**  
**LARGE**  
**SATINATO**

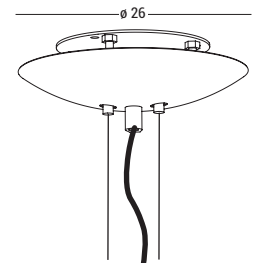

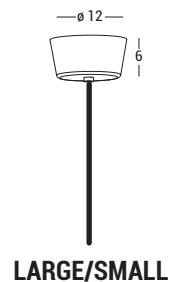
codice  
codeGLO  
TITANIO  
E BIANCO

LARGE/SMALL

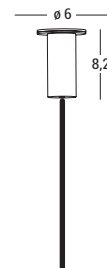
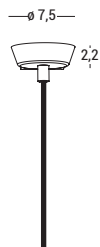
MoM  
BIANCO  
NEROGLO MINI  
ACORN  
TITANIO  
E BIANCO

MINI

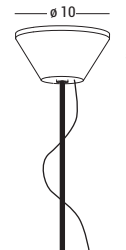
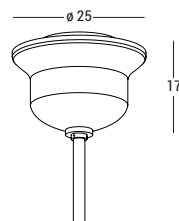
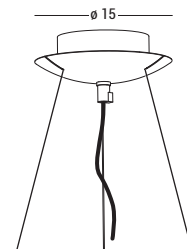
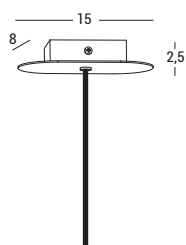
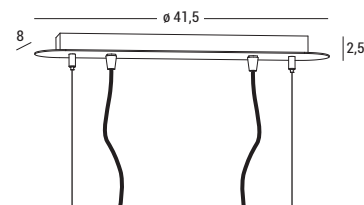
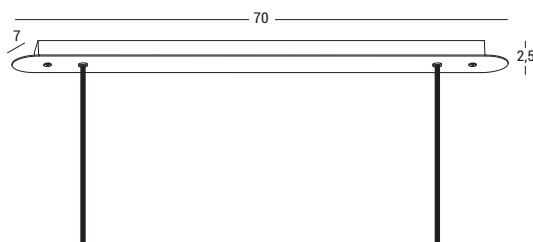
PLANET  
SATINATOJEI JEI  
VETROSOSPENSIONI  
TESSUTO:  
Ø 100  
SQUARE  
OVAL  
SATINATOLUUME 1  
CROMO  
LUCIDOTOCCO  
SATINATOLUUME  
LARGE  
CROMO  
LUCIDOUP-DOWN  
CROMO  
LUCIDO

codice  
code

**WOOD**  
LEGGNO

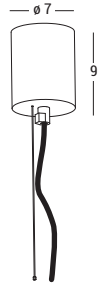

**ROSONE AD  
ASTA RIGIDA**  
SATINATO

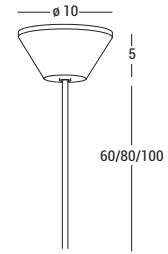

**SUPPORTO A MURO / WALL SUPPORT**

**WOODY**  
SATINATO

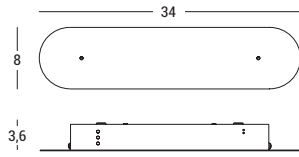

**VANITY/  
CLUB HOUSE**  
VERNICIATO  
ARGENTO

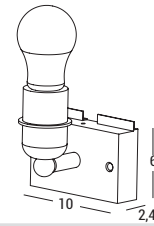



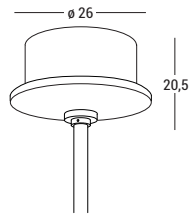



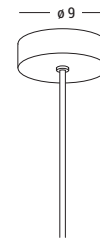



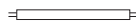

























**VERTIGO**  
NERO LUCIDO  
BRONZO



**WONDER**  
ORO OPACO  
RAME OPACO  
GRAFITE OPACO



# Lampadine Bulbs

42W - E14 oliva		15W - G13 fluorescente	
25/40/42/60W - E14		30/36W G13 fluorescente	
60W - E27 sfera		14W - G5 fluorescente	
60/70/100/105/150W - E27		28W - G5 fluorescente	
4/5W - E14 sfera led		49W - G5 fluorescente	
8/10/10,5W - E27 goccia led		50W GU10 alogena	
40/60/75W - E14 alogena		3W Led	
60/100/150/250W - E27 alogena		7W Led	
100/150W - B15 alogena		22W Led	
60/100/150/250W R7s 78 mm alogena		7W Led - GU10	
100/150/200/300W R7s 117 mm alogena		20 W - E27 fluorescente	
9W - G23 fluorescente		7W Led	
11W - 2G7 fluorescente		4/8/13/17W - Led	
18/24/36W - 2G11 fluorescente		7/12/14/15/24,5/28,8/58W - Led	
11W - E14 fluorescente		20W - 12V - G4 alogena	
25W - E27 fluorescente		28/33/42/60W - G9 alogena	
16W - E27 globo led		2W - 12V G4 led	
8W - E14 fluorescente		3/5W - G9 led	
15W - E27 fluorescente			

Note:  Simbolo di conferma che la lampadina viene fornita con la lampada  
*Symbol that confirms that the bulb is supplied with the lamp.*

La tensione s'intende 230V, 50/60HZ o 120V, 60HZ a seconda dei paesi.  
*Voltage: 230V, 50/60HZ or 120V, 60 HZ according to the country.*













Le lampadine incandescenti possono essere sostituite dalle corrispondenti alogene.  
*The incandescent bulbs can be replaced by the corresponding halogen ones.*

• for USA **E14 becomes E12**  
**E27 becomes E26**



I lumen non sempre corrispondono. Verificare sempre le dimensioni. Rif. Leuci  
*Lumen don't always match. Always check the dimensions. Ref. Leuci*

# Legenda Legend

## Simboli Symbols

 lampadina compresa <i>bulb included</i>	 IP44 Apparecchio a prova di penetrazione di oggetti solidi con $\varnothing$ superiore a 1 mm. Apparecchio protetto contro gli spruzzi d'acqua da ogni direzione. <i>Protected against penetration of solid objects larger than 1 mm. Protected against splashing water from any direction.</i>
 diametro <i>diameter</i>	
 altezza <i>height</i>	 CE Attesta la conformità del prodotto alle direttive europee. <i>Certifies the conformity of the product to the european community provisions.</i>
 larghezza <i>width</i>	
 profondità <i>depth</i>	
  ISO 9001	
SISTEMA DI GESTIONE QUALITÀ CERTIFICATA AZIENDA CERTIFICATA	
 TOUCH Dimmer sensoriale. <i>Touch dimmer.</i>	 Dimmer. <i>Dimmer.</i>
 Dimmer. <i>Dimmer.</i>	
 Distanza dall'oggetto illuminato. <i>Distance from the lighted object.</i>	

## Classe Class

 CLASSE I Solo isolamento fondamentale; le parti conduttrici sono collegate ad un conduttore di terra. Messa a terra: tassativa. <i>Only basic insulation, accessible conductors are grounded. Grounding: compulsory.</i>
 CLASSE II Con doppio isolamento e/o rinforzato in ogni parte senza dispositivi per la messa a terra. <i>Class of insulation Class II. With double insulation and/or reinforced in every part and without eart connections</i>
 CLASSE III Alimentazione effettuata con bassissima tensione di sicurezza; tensioni superiori a 50 Volt (a 50Hz) sono escluse in ogni parte e in ogni circostanza. Messa a terra: esclusa. <i>Very low safety supply voltage; not to be used at over 50V (at 50Hz). Grounding: excluded.</i>

Il dimmer potrebbe causare tremolio della luce se si utilizza una lampadina di wattaggio inferiore a quella indicata come potenza minima.

**Non è garantito il corretto funzionamento del dimmer con lampadine LED retrofit o fluorescenti compatte con alimentatore integrato.**

La potenza di lampada indicata, riferita alle sorgenti alogene, è da valutare singolarmente per l'alternativa fluorescente compatibilmente con l'ingombro della lampadina.

*The dimmer could cause flickering of the light if you use a bulb with a lower wattage than the one indicated as per minimum power.*

***We do not guarantee the right working of the dimmer with led retrofit or compact fluorescent bulbs with incorporated feeder.***

*The wattage indicated for each lamp, referred to the halogen sources, should be valued individually for the fluorescent option according to the size of the bulbs.*

**ECOLIGHT**

EFFICIENZA E PROFESSIONALITÀ PER L'AMBIENTE

PENTA srl aderisce al Consorzio Ecolight per l'attuazione delle direttive WEEE/RAEE 2002/95/CE e 2003/108/CE relative alla raccolta e smaltimento delle apparecchiature di illuminazione.

*Penta srl takes part in Consorzio Ecolight for the implementation of directive WEEE/RAEE 2002/95/CE e 2003/1087/CE relating to collection and discharge of lighting fittings.*

## Tabella tessuti per modelli lampade / Fabric matchings

Categoria / Class	EXTRA	EXTRA	A	A	A	A	A	A	A	B	B	B
Lampada Lamps	Raso seta Silk satin	Plissé seta a mano Hand made silk plissé	Canapa Hemp (H.max 90 cm.)	Lino Linen	Linone Lawn	Net	Shantung	PVC specchiato Mirroring PVC	Seta Silk	Cotone Cotton	Pergamena Parchment	PVC
ABA HI-TECH / ABA VIP	•		•	•	•	•	•		•	•	•	•
BRIDGET	•		•	•	•	•	•		•	•	•	•
CLUB HOUSE APPLIQUE	•		•	•	•	•	•		•	•	•	•
KELLY	•		•	•	•	•	•		•	•	•	•
LUXURY	•	•	•	•	•	•	•		•	•	•	•
NEW CLASSIC table	•		•	•	•	•	•	•	•	•	•	•
SLIDE	•	•	•	•	•	•	•		•	•	•	•
SOSPENSIONI	•		•	•	•	•	•	•	•	•	•	•
TIC & TOC	•			•	•	•	•	•	•	•	•	•
TOSCA	•	•	•	•	•	•	•		•	•		
UP-DOWN	•		•	•	•	•	•	•	•	•	•	•
VANITY	•	•	•	•	•	•	•		•	•	•	•
WOOD	•				•		•					

**Tessuti cat. Extra, A e B / Fabrics Extra, A and B class**

**Tessuti supportati da PVC autoestinguente / Fabrics glued with self-extinguishable PVC**

Penta si riserva il diritto di apportare ai propri modelli, senza alcun preavviso, modifiche e migliorie che potrebbero variare l'estetica delle soluzioni pensate.

*Penta reserves the right to charge, better and improve its models without notice, also if these improvements might change the aesthetical image of the proposed solutions.*

I vetri realizzati rigorosamente a mano dal maestro vetraio rispettano le antiche e tradizionali tecniche di soffiatura. Ogni articolo è sottoposto a meticolosi controlli di qualità, pertanto apparenti difetti come bolle o variazioni dei toni di colore del vetro, sono riconosciuti come pregi e conferma della lavorazione artigianale.

*Glasses are hand made and mounth blown by the master glass blower, according to the traditional techniques of blowing. Each item is carefully checked, therefore apparent imperfections, such as bubbles or nuances in the glass colour, have to be recognised as qualities and sign of the artisan's craftsmanship.*

# Note



# Note







PENTA srl - via Milano 46 - 22060 Cabiato - Como - Italy  
T +39 031 766 100 - F +39 031 756 102 - [www.pentalight.it](http://www.pentalight.it) - [info@pentalight.it](mailto:info@pentalight.it)